



VIVAX
METROTECH

vLoc3 Series Receiver's User Handbook vLoc3-Pro, vLoc3-XLF and vLoc3-ML (English Edition)

Version 1.0

P/N: 4.04.000226



vLoc3-Pro



vLoc3-XLF



vLoc3-ML

General Safety & Care Information

Who Can Use This Equipment

- This equipment must only be used by people suitably trained in the use of pipe and cable locators.

Work-site Safety

- Use your company's or other applicable safety codes and rules when using this equipment.
- Unless having the required authorization, license, and appropriate training, do not connect to any pipe, cable, or conductor.
- The equipment should not come in contact with corrosive or hazardous chemicals or gases, or dust.
- **Do not** directly connect this equipment to cables or pipes with a potential difference to ground greater than 25V AC.

Equipment Safety

- **Do not** open the enclosures (housings) of either the transmitter or receiver.
- Place the ground stake firmly in the ground before connecting the cable from the transmitter.
- **Do not** hold any uninsulated portion of the connection leads & clips when the transmitter is switched on.

Batteries and Environmental Safety

Vivax-Metrotech products use four types of batteries:

- Alkaline batteries
- Ni-MH (Nickel-Metal Hydride) batteries – rechargeable
- Lithium-Ion batteries – rechargeable
- Lithium-Metal batteries – (small non-rechargeable button cells for "clock" applications)

1. Alkaline Batteries (Non-Rechargeable)

- When replacing the alkaline batteries – use only the size and type specified – **do not** mix battery types (rechargeable and alkaline).
- **Do not** mix partially discharged and fully charged cells in the same battery pack – **do not** mix old with new.
- **Never** attempt to charge alkaline batteries.

2. Nickel-Metal Hydride Batteries (Rechargeable)

- When using rechargeable batteries, use only the correct charging device supplied or specified by the manufacturer. The battery pack or the battery charger will contain circuitry to manage the charging process – other chargers (even if they have the same connector, polarity, voltage & current rating will not have the same control circuitry and can cause damage to the product, overheating, and in extreme cases fire or harm to the individual.
- **Do not** assume that if the plug fits, it is the correct charger – a charger with the correct part number **must** be used – just because it is a Vivax-Metrotech charger and the plug fits **does not** mean it is the correct charger.
- Before using for the first time, charge rechargeable batteries for six hours. If the rechargeable batteries do not last as long as anticipated at any time, discharge fully and then charge for six hours.
- Care should be taken when charging batteries – **Never** repeatedly recharge batteries (or turn the power off & on) without using the instrument. If used with an inverter in a vehicle – charge the product, unplug the charger, and **not** charge again until the rechargeable batteries have been used for at least ten minutes. Failure to do this could result in the overcharging of the battery, which will shorten the battery's life and could, in some circumstances, cause overheating or fire.
- If the product becomes hot during the charging process, **immediately** unplug the charger and use the rechargeable batteries for at least ten minutes before recharging. If this reoccurs the next time the unit is charged – return immediately to Vivax-Metrotech for repair.
- **Do not** charge batteries for prolonged periods without using the locator for at least ten minutes. Charging for a prolonged period could overcharge the battery, reduce battery life, and in extreme circumstances, cause damage to the locator and fire.

3. Lithium-Ion Batteries (Rechargeable)

- Lithium-Ion Batteries – some products use Lithium-Ion batteries – the requirements for marking and transportation are still developing. Please contact Vivax-Metrotech before shipping products containing Lithium-Ion batteries or Lithium-Ion battery packs on their own for any "special instructions."

4. Lithium-Metal Batteries (Non-Rechargeable)

- Commonly known as "button cells," these are small – non-rechargeable batteries used to power internal "clocks" within some units (similar to computers). Generally, they have a life of three to five years.
- Under no circumstances should any attempt be made to charge these batteries.
- Dispose of following your company's work practice/environmental standards, the prevailing laws, or recognized best practice. Always dispose of batteries responsibly.

5. General Rules regarding Disposal of Batteries

- **Never** disassemble a battery or battery pack.
- **Never** dispose of in a fire or water.
- Dispose of batteries following your company's work practice/environmental standards, the prevailing laws, or recognized best practice. Always dispose of batteries responsibly.

6. Transportation of Lithium-Ion and Lithium-Metal Batteries

- The Lithium-Ion and Lithium-Metal batteries used in Vivax-Metrotech products meet the required safety standards and include the designated protection circuitry.
- Recent regulation changes require that when batteries with Lithium-Ion and Lithium-Metal batteries are transported, the packaging **must** include specified warning labels.
- **Please contact Vivax-Metrotech Customer Service (USA 1-800-446-3392, International +1-408-734-1400 (USA Pacific Time Zone)) for more details.**
- Regulations have also changed regarding the shipping of spare battery packs (battery packs that are not inside a product). There are limitations on the package's weight, and the packaging must be marked with the appropriate warning labels.
- **Please contact Vivax-Metrotech Customer Service (USA 1-800-446-3392, International +1-408-734-1400 (USA Pacific Time Zone)) for more details.**
- Vivax-Metrotech vLoc Series 3 products using Lithium-Ion battery are classified as "not restricted" and can be shipped normally by road/rail/sea & passenger & freight aircraft without restrictions.



IMPORTANT

Batteries contain dangerous chemicals. They can be affected by many things, such as water ingress or heat. In some circumstances, they can explode. They also can cause electric shocks!

Care of Equipment

- Use equipment only as directed in this User Handbook.
- **Do not** immerse any part of this equipment in water.
- Store in a dry place.
- Keep equipment in the case provided when not in use.
- If left for a prolonged period – remove alkaline batteries.
- Keep the unit clean and free of dust and dirt.
- Protect against excessive heat.

Care when Interpreting the Information provided by the Locator

- Like all locators – this instrument is locating and providing depth and current readings based on electromagnetic signals that radiate from the buried cable or pipe. In most cases, these signals will enable the locator to pinpoint both position depth and current correctly.
- **Beware** – in some cases, other factors will distort electromagnetic fields radiating from the cable or pipe is located, resulting in incorrect information.
- Always locate responsibly and use information learned during your training to interpret the information provided by the locator.
- **Do not** provide information regarding cable or pipe depth to anyone unless authorized to do so by your company.
- **Remember** that depth measurements are to the center of the electromagnetic field or pipe – In the case of pipes, this may be significantly deeper than the top of the pipe.

American & Canadian Safety Notices

USA

- This transmitter and receiver comply with the general conditions of operation, according to part 15 of the FCC Rules.
 - o CFR 47 Part 2
 - o CFR 47 Part 15
- Changes or modifications not expressly approved by the manufacturer could void the user's authority to operate the products.







CANADA

- Equipment is for use by trained operators only and not for general household or consumer use.
- Operation is subject to the following two conditions: (1) this device may not cause interference, and (2) this device must accept any interference that may cause undesired operation of the device.







EUROPE

- Vivax-Metrotech confirms that the location system is compliant with the relevant provision of European directive 1999/5/EC.
 - o EN 55011
 - o EN 61000-4-2: A1 & A2
 - o EN 61000-4-3
 - o EN 61000-4-8: A1
 - o ETSI EN 300 330-2
 - o ETSI EN 301 489-1
 - o ETSI EN 301 489-3

Table of Content

- 1. Service & Support1
 - 1.1 Serial Number and Software Revision Number.....1
 - 1.2 Distributors and Service Centers Closest to You:.....2
- 2. vLoc3 Series Receivers3
 - 2.1 vLoc3 Series Receivers Overview.....3
 - 2.2 Charging the Receiver Batteries4
 - 2.3 The vLoc3 Series Keypad5
 - 2.4 The vLoc3 Series User Menu5
 - 2.4.1 Setup - Receiver5
 - 2.4.2 Setup - Operational6
 - 2.4.3 Setup - Feature7
 - 2.4.4 Setup - Informational7
 - 2.5 Self-Test7
 - 2.6 Warnings and Alerts8
 - 2.6.1 Warning and Alerts Descriptions8
 - 2.6.2 DFT (Discrete Fourier Transform)8
 - 2.7 vLoc3 Series Locate Modes and Screens9
 - 2.7.1 The Classic Screen Status Bar10
 - 2.7.2 The Classic Screen10
 - 2.8 Classic Locating Modes (Response).....11
 - 2.8.1 Peak Response Mode 11
 - 2.8.2 Broad Peak Mode 11
 - 2.8.3 Null Mode 11
 - 2.8.4 Delta Null Mode 11
 - 2.8.5 Peak with Arrows Mode 12
 - 2.8.6 Omni Peak Response Mode 12
 - 2.8.7 Information Pushbutton  (Depth & Current)12
 - 2.9 Alternative Locate Screens.....13
 - 2.9.1 The Vector Configuration Screen13
 - 2.9.2 The Transverse Plot Screen.....14
 - 2.9.3 The Plan View Screen.....14
- 3. Using the vLoc3 Series Receivers16
 - 3.1 Passive Locating16
 - 3.1.1 Detecting Power Signals16
 - 3.1.2 Detecting Radio Signals.....17
 - 3.2 Active Locating: Applying the Transmitter.....18
 - 3.2.1 Direct Connection.....18
 - 3.2.2 Signal Clamp (for frequencies above 8kHz).....19
 - 3.2.3 Induction (for frequencies above 8kHz)20
 - 3.3 Locating Active Signals21
 - 3.4 Searching (sweeping) an Area in the Peak Mode23
 - 3.5 Searching an Area in the Omni Peak Mode23
 - 3.6 Tracing a Buried Line23
 - 3.7 Depth & Current Measurement23
 - 3.8 Distorted Fields24
 - 3.9 Sonde Location Mode25
 - 3.10 Signal Direction Precision Identification Mode26



4.	vLoc3-ML Receiver	29
4.1	Serial Number and Software Revisions	29
4.2	vLoc3-ML Receiver	30
4.3	Locating Markers with the vLoc3-ML & vLoc3-MLA	30
4.3.1	Operating the Receiver	30
4.3.1.1	Dedicated Marker Mode	30
4.3.1.2	Dual Configuration	32
4.4	vLoc3-MLA	33
4.4.1	Set-up the vLoc3-MLA	33
4.4.1.1	Operation of the vLoc3-MLA	34
4.4.1.2	Marker Depth Estimation with the vLoc3-MLA	34
5.	Data Logging	36
5.1	Bluetooth  Bluetooth	37
5.1.1	Fitting the Bluetooth Module	38
5.2	Pairing with external GPS or Dataloggers	38
5.3	Transferring Data from the vLoc3 Receiver to a Computer	39
5.3.1	MyLocator3	39
5.3.2	MyLocator3's Basic Operation	39
5.3.2.1	Updates Page	39
5.3.2.2	Application Update	40
5.3.2.3	Locator Firmware update	40
5.3.3	Toolbar	41
5.3.4	Data Logging 	41
5.3.5	Splash Screen 	42
5.3.6	Frequencies Page 	44
5.3.7	Menu Settings 	44
5.3.8	Advanced Features	45
5.3.8.1	Supervisor Lockouts	45
6.	The Loc3 Series Transmitters	46
6.1	Loc3 Series Transmitter Overview	46
6.2	The Transmitter Display	46
6.3	Pushbuttons	47
6.3.1	Transmitter Information Pushbuttons	47
6.3.2	Transmitter Connections Block	48
6.4	Transmitter Batteries – Li-ion and Alkaline	48
6.5	Charging the Transmitter Battery Tray	49
6.6	Removing and Installing the Battery Tray	50
6.7	Transmitter Modes	50
6.7.1	Direct Connection Mode	51
6.7.2	Clamp Mode	51
6.7.3	Induction Mode – 5 and 10-Watt Transmitters Only	52
6.8	Transmitter Frequencies	52
6.8.1	Frequencies and Maximum Power Output	52
6.8.2	Most Used Frequencies (Frequency Selection) Feature	53
6.8.3	Multi-Frequency Mode for Direct Connection	54
6.9	Transmitter Link (TX-Link) 	55
7.	Locator Accessories	58
7.1	Transmitter Signal Clamps	58
7.2	A-Frame Fault Locator	58
7.3	vLoc3-MLA (Marker Locator Adapter)	58
8.	Glossary	59

1. Service & Support

1.1 Serial Number and Software Revision Number

Always quote your receiver and transmitter model number, serial number, and software revision number when requesting product support. They can be found as follows.



1	Model & Serial Number
---	-----------------------



NOTE

Software Revision Number: On both receiver and transmitter, the software revision number is displayed on the LCD during the startup sequence or found in the “About” section of the user menu.



Receivers with the **SD** option installed will show this icon label on the blade where it meets the yellow upper housing.



Receivers with the **Tx-Link** option installed will show this icon label on the blade where it meets the yellow upper housing.
Transmitters with the **Tx-Link** option installed will show this icon label on the upper corner of the housing.

1.2 Distributors and Service Centers Closest to You:

Worldwide Sales Offices and Service Centers	
World Headquarters, United States of America	Central/South America and the Caribbean
<p>Vivax-Metrotech Corporation 3251 Olcott Street, Santa Clara, CA 95054, USA</p> <p>T/Free : 1-800-446-3392 Tel : +1-408-734-1400 Fax : +1-408-734-1415 Website : www.vivax-metrotech.com Email : SalesUSA@vxmt.com</p>	<p>Ventas para América Latina 3251 Olcott Street, Santa Clara, CA 95054, USA</p> <p>T/Free : 1-800-446-3392 Tel : +1-408-734-1400 Fax : +1-408-743-5597 Website : www.vivax-metrotech.com Email : LatinSales@vxmt.com</p>
Canada	France
<p>Vivax Canada Inc. 41 Courtland Ave Unit 8, Vaughan, ON L4K 3T3, Canada</p> <p>Tel : +1-289-846-3010 Fax : +1-905-752-0214 Website : www.vivax-metrotech.com Email : SalesCA@vxmt.com</p>	<p>Vivax-Metrotech SAS Technoparc - 1 allée du Moulin Berger, 69130 Ecully, France</p> <p>Tel : +33(0)4 72 53 03 03 Fax : +33(0)4 72 53 03 13 Website : www.vivax-metrotech.fr Email : SalesFR@vxmt.com</p>
Germany	United Kingdom
<p>Metrotech Vertriebs GmbH Am steinernen Kreuz 10a, D-96110 Schesslitz</p> <p>Tel : +49 954 277 227 43 Website : www.vivax-metrotech.de Email : SalesEU@vxmt.com</p>	<p>Vivax-Metrotech Ltd. Unit 1, B/C Polden Business Centre, Bristol Road, Bridgwater, Somerset, TA6 4AW, UK</p> <p>Tel : +44(0)1793 822679 Website : www.vivax-metrotech.com Email : SalesUK@vxmt.com</p>
China	International Distributors and Service Centers
<p>Vivax-Metrotech (Shanghai) Ltd. 3/F No.90, Lane 1122 Qinzhou Rd.(N), Shanghai, China 200233</p> <p>Tel : +86-21-5109-9980 Fax : +86-21-2281-9562 Website : www.vivax-metrotech.com Email : SalesCN@vxmt.com.cn</p>	Australasia
	<p>Vivax-Metrotech AUS Unit 1, 176 South Creek Road, Cromer NSW 2099, Australia</p> <p>Tel : +61-2-9972-9244 Fax : +61-2-9972-9433 Website : www.vivax-metrotech.com.au Email : sales@vxmtaus.com, service@vxmtaus.com</p>
	China
	<p>Shanghai Vimap Technology Co. Ltd. 9/F, Building 89, Xinhuiyuan, No.1122 Qinzhou North Road, Shanghai, China 200233</p> <p>Tel : 4000-999-811 Website : www.vimap.cn Email : info@vimap.cn</p>

2. vLoc3 Series Receivers

This user manual covers the **vLoc3-Pro**, **vLoc3-XLF**, **vLoc3-ML** receivers, and **vLoc3-MLA Adapter**. For the most part, the features and functions of these receivers are the same. Where different they will be noted.

These receivers will be referred to as vLoc3 series, vLoc3 receiver, receiver, or locator.

The vLoc3 Series Receivers are precision locators designed to meet the needs of utility companies and their contractors. The following describes the features and use of the receiver.

2.1 vLoc3 Series Receivers Overview

The below applies to the **vLoc3-Pro** and **vLoc3-XLF** receivers. The **vLoc3-ML** and **vLoc3-MLA** are covered in **section four** of this manual.

What's in the box:



Compartments and Controls

1	Pushbutton keypad and display	5	Mini-USB port
2	Model number & Serial number label	6	Battery compartment cover
3	Battery retaining cover	7	Charging and accessory socket
4	Battery compartment	8	Bluetooth expansion port

2.2 Charging the Receiver Batteries

The vLoc3 series receivers can be used with the alkaline or the custom Li-ion rechargeable battery pack.



The central illuminated section within the battery icon indicates the amount of charge remaining.

- Blue centre indicates alkaline batteries.
- Green centre indicates rechargeable batteries.
- When batteries are low the charge remaining section becomes red and will flash.
- Just before shutdown the following symbol will be shown:



Rechargeable batteries are supplied with a mains charger specific to the batteries. Avoid using other manufacturers' chargers as these may damage the battery and may result in overheating. To charge the battery, first make sure the battery pack is inserted in the receiver's battery compartment as charging is done with the battery inside the receiver.



Connect the charger to the receiver's charging/accessory socket. Connect the charger to the mains and switch it on. The LED indicator on the charger will illuminate red until the batteries are fully charged, at which time the LED will change to green.



WARNING

Rechargeable batteries are supplied with a mains or 12V DC charger. The charger is specific to the battery. Only use the charger that is appropriate for the battery in the product. If in doubt, call the Vivax-Metrotech customer service department at +1(800) 446-3392. Failure to use the appropriate charger could damage the battery pack, locator and cause a fire in extreme cases.

Avoid charging the unit in extreme temperature conditions, i.e., below 0°C and above 45°C.

Although Vivax-Metrotech batteries include all the required safety-related features, immediately discontinue the charger and battery pack's use if the battery pack becomes excessively warm. Return both to where they were purchased for investigation.

Always ensure batteries have at least a partial charge if storing for long periods without use.

Dispose of all batteries following your company procedures and or Federal/State and local regulations.

Never dismantle batteries, put them in a fire, or get them wet.

2.3 The vLoc3 Series Keypad

The grey color keys (3, 5, and 6) serve dual functions. You may have to **short press** by momentarily pressing the key or **long press** by pressing and holding the key until the desired function is shown.

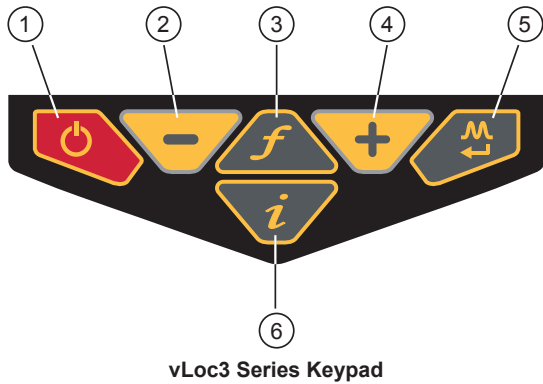

1	On/Off
2	Reduce sensitivity. (Also scroll up when in menu)
3	Select frequency Long press = show the pre-selected frequency table
4	Increase sensitivity. (Also scroll down when in menu)
5	Enter Key Short press = change antenna response when in classic screen Long press = change the locate perspective
6	Information and Depth key Short press = enter the information and logging screen Long press = enter the menu

2.4 The vLoc3 Series User Menu

The user-configurable vLoc3 series receivers can be customized to suit the user's preferences. The receivers have several features that can be switched on and off through the user menu.

This section covering the user menu is split into four subsections;

Setup – Covering the settings that are usually chosen and not often changed. Most of these settings apply to the locator's physical attributes such as language, sound, and measure units.

Operational – Covers the locate screens and locate perspective.

Features – Are optional modes and physical add-ons such as Bluetooth, Marker Locator Adapter, and other options that may have been ordered.

Informational – Covers the receiver's configuration, firmware version, and regulatory information.

It is recommended that the **setup section** be done first. It will be easier to finish the receiver's setup if it is done in the native language.

To enter the user menu, press and hold the "i"  key, release the key when in the menu.

Note that where you see this symbol , pressing the enter button gives access to the sub-menu associated with this button.

To exit the menu or sub-menu, press the "i"  button.

Where the  icon is not shown, the enter button is used to scroll through the options of that feature.

Use the "+" and "-" buttons to scroll up and down through the menu.

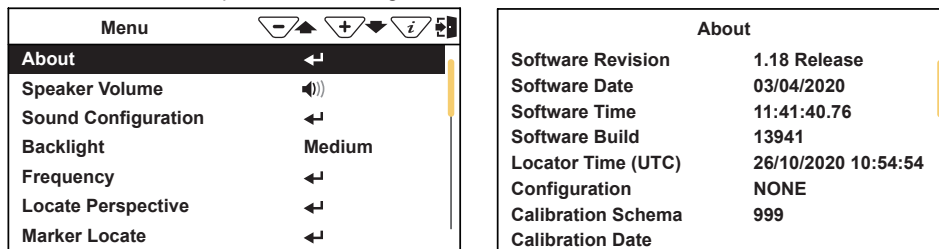

Main Menus

2.4.1 Setup - Receiver

Language – The receiver can be programmed in different languages. Repeatedly pressing the Enter key cycles through the list of available languages.

Speaker Volume – Repeatedly pressing the Enter key raises the speaker volume by three levels and then turns off the volume. When off  is displayed.

Backlight – Press the Enter key to change the backlight intensity to Low, Medium, High, or Auto. The use of the “Auto” selection is recommended because the receiver has a built-in light sensor that automatically adjusts the backlight intensity to the surrounding lighting conditions. Auto-selection may improve battery life performance.

Sound Configuration - Changes the sound configuration of the locate modes. Use the Enter key to select **AM** or **FM**.

- **When in active locate modes:**
 - Frequency Modulated (**FM**) Sound pitch changes with signal strength
 - Amplitude Modulated (**AM**) Sound volume changes with signal strength
- **When in passive locate modes:**
 - Radio mode: **FM** or **Real** (Sound derived directly from the received signal)
 - Power mode: **FM** or **Real**

Imperial/Metric – Use the Enter key to select Imperial or Metric measurements for the depth readings.

Continuous Info – The locate screens can display a continuous reading of either depth, current, both, or can be switched off. Use the Enter key to select your preference.

Auto Power Off – The unit can be set to switch off after a set time. Options are 5-minutes, 10-minutes, or Never. Note that when the accessory A-frame is connected, the timer defaults to “Never.”

2.4.2 Setup - Operational

Frequency - Press the Enter key to enter the Frequency sub-menu. Scroll up and down the table of available frequencies using the “+” and “-” keys.



TIP
Simplify the operation of the receiver by selecting only the frequencies applicable to your application. To do this, use the enter key to check the boxes on the right. Frequencies not checked will not appear on the locate screen.

Frequency	
8.01kHz	<input type="checkbox"/>
8.19kHz	<input checked="" type="checkbox"/>
8KFF	<input checked="" type="checkbox"/> A
8.44kHz	<input type="checkbox"/>
9.50kHz	<input type="checkbox"/>
9.80kHz	<input type="checkbox"/>
9.82kHz	<input checked="" type="checkbox"/>
10.0kHz	<input type="checkbox"/>



NOTE
Certain frequencies have an A-frame icon next to them. This icon indicates that these frequencies are selected to be used with the fault find A-frame.

Classic Locate – This option is only shown if the menu is entered from the Classic Screen. Use the enter key to reveal the list of options relating to the Classic Locate mode. Options are:

Classic Locate	
Peak	<input checked="" type="checkbox"/>
Peak With Arrows	<input checked="" type="checkbox"/>
Null	<input checked="" type="checkbox"/>
Broad	<input checked="" type="checkbox"/>
Delta Null	<input type="checkbox"/>
Omni Directional Peak	<input checked="" type="checkbox"/>
Omni Directional Broad	<input checked="" type="checkbox"/>

Locate Perspective – Enter this menu to select the graphical format that the locate data will be displayed. These displays are described further in the manual. The options are:

Locate Perspective	
Classic Locate	<input checked="" type="checkbox"/>
Vector Locate	<input checked="" type="checkbox"/>
Transverse Graph	<input checked="" type="checkbox"/>
Plan View	<input checked="" type="checkbox"/>
Sonde	<input checked="" type="checkbox"/>

2.4.3 Setup - Feature

Warnings – Warnings relating to - Shallow cable, Overload, Overhead cable, and Signal Overload. Scroll down to the relevant warning and use the return button to select or de-select.

Bluetooth Pairing (if installed) – This option allows the receiver to link with external devices such as data loggers and GPS devices with Bluetooth capability. Press the enter button to enter the Bluetooth pairing routine.

Bluetooth Auto Connect – When this option is enabled, the receiver will automatically connect with any previously paired Bluetooth device.

Transmitter Link – The Loc3 series transmitters can be remotely operated from the receiver. This option requires the Transmitter (radio) Link to be installed in both the vLoc3 series receiver and the Loc3 series transmitter. Tx-Link is a factory fit option that must be purchased at the time of ordering. Currently, the Tx-Link feature is **only available in the Loc3 series 5-watt and 10-watt** transmitters.

Transmitter Control – This feature is used to control a transmitter with the Radio Link activated remotely. For more information, see the section “Remote Operation of the transmitter.”

DFT – Discrete Fourier Transform is a tool to help choose a frequency to apply to the target conductor. The DFT feature will aid the user with nearby interference that may affect the locate quality.

2.4.4 Setup - Informational

About – This section holds the data about the locator, such as software revision, calibration data, etc.

Regulatory Labels – This section shows the required FCC ID and IC information.

Self-Test – The vLoc3 series receivers have a self-test feature that confirms the equipment is fit for use and that the calibration has not drifted from its expected settings.

2.5 Self-Test

The Self-Test feature must be run in an area free from interference, such as overhead fluorescent lighting, large transformers, etc. Also, check that any nearby transmitters or sondes are switched off.

Select “Self-Test” from the user menu and press the “Return” button. Keep the receiver stationary while the test is running. After a short while, the test will complete, and the unit will report Passed or Failed.

	Self Test: PASSED					
		110.3	✓	✓	✓	✓
		110.3	✓	✓	✓	✓
		64.1	✓	✓	✓	✓
		110.3	✓	✓	✓	✓
		110.3	✓	✓	✓	✓
	Self Test: FAILED					
		109.6	X	X	✓	✓
		109.9	X	X	✓	✓
		64.3	X	X	✓	✓
		109.7	X	X	✓	✓
		109.9	X	X	✓	✓

Examples of the Self-Test results

If the receiver fails the test, try again in an area with less interference. If it continues to fail, return the unit to Vivax-Metrotech or one of its approved repair centers for investigation.

2.6 Warnings and Alerts

Warning symbols accompanied by an audible sound and vibration in the handle unless configured otherwise in the MyLocator3 desktop app. Warnings can also be switched off in the setup menu.

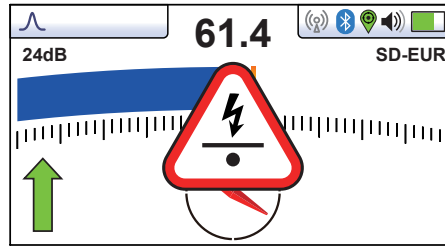

2.6.1 Warning and Alerts Descriptions

ALERT	Alert Description
	Signal Overload - is usually caused by operating close to power transformers or being close to a transmitter in Induction mode. Moving away from the interfering signal will solve the problem.
	Shallow Cable - alerts indicate that the locator has detected a possibly less than 15cm (5.9-inch) deep cable. Proceed with caution.
	Swing Alert - indicates that the operator is swinging the locator excessively, resulting in misleading information. When sweeping the locator across the direction of the line, try to keep it vertical; this will improve its accuracy.
	Overhead Cable - alerts indicate that the source of the signal is mainly radiating from above. This alert is usually caused by the signal traveling along overhead cables.

2.6.2 DFT (Discrete Fourier Transform)

DFT is a tool to assist in choosing a frequency to apply to the target conductor. The DFT feature will aid the user with nearby interference that may affect the locate quality.



***Note the DFT feature should not solely be used to determine which frequency to apply. ALWAYS follow the appropriate safety requirements mandated by safety legislation, safety practice, or your company's safety procedures when applying a locate frequency to a conductor.**

- To perform a DFT assessment, verify any nearby transmitters are powered off to avoid additional signal frequency disturbance.
- Select your preferred frequencies from the frequency menu. These selected frequencies will be assessed in the next few steps.

Frequency	
128Hz	<input type="checkbox"/>
480Hz	<input type="checkbox"/>
491Hz	<input checked="" type="checkbox"/>
512Hz	<input checked="" type="checkbox"/>
577Hz	<input type="checkbox"/>
815Hz	<input type="checkbox"/>
982Hz	<input type="checkbox"/>
1.02kHz	<input type="checkbox"/>

- Navigate to the main menu and scroll until you see DFT. Select DFT by pressing the enter key.
- Once the option is selected, the receiver will automatically assess the user's preselected frequencies.

2 vLoc3 Series Receivers

- The receiver will scan all available frequencies and display a progress bar and the list of frequencies assessed will be displayed. The frequency under test is shown on the top line.



- A numerical value ranging from 0dB to 140dB will be shown next to the frequency list with 140dB being the least possible interference detected and 0db with the largest amount of possible interference.
- The results are ranked from the least interference possible at the top to the largest amount of most possible interference at the bottom.
- In this case, the higher the dB number (80dB), the less interference has been detected by the receiver.

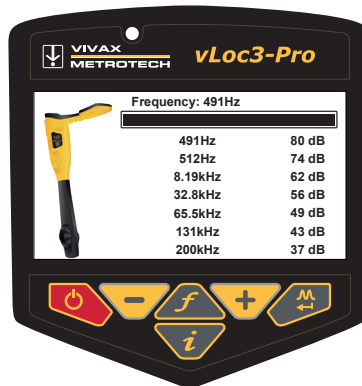

NOTE

Although frequency results appear to have less interference, it still does not make it the best choice to locate certain utilities. These include but are not limited to a conductor, current output, resistance, and signal bleed over adjacent utilities.

2.7 vLoc3 Series Locate Modes and Screens

Note - The vLoc3 series user interface is under continual development. The screenshots described here may differ slightly from your screens.

The vLoc3 series receivers give the user a choice of locating screens.

The choice of the screen depends on the application and user preference. These screens are:

- Classic Locate
- Plan View Locate
- Sonde Location
- Vector Locate
- Transverse Locate

First we will explain the functions of the "Classic Screen," as familiarity with this screen will help understand others' functions.

2.7.1 The Classic Screen Status Bar

All vLoc3 series screens have a status bar at the top indicating various locator settings.

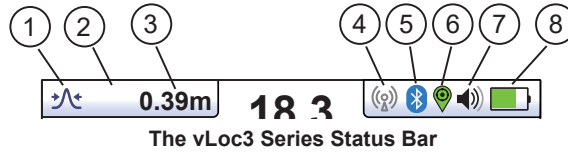

1	Antenna configuration (meter response) described later in the manual	5	Bluetooth status (If Transmitter link is fitted this icon will replace the blue tooth icon as they are mutually exclusive)
2	Other future option	6	GPS status (see below for further explanation)
3	Signal Current/Depth to the target line. (can also be set to display signal current on the line or both)	7	Speaker volume setting
4	Transmitter Link connection status (see section 5.5)	8	Battery type and remaining charge

2.7.2 The Classic Screen

The Classic Screen - has all the functions normally seen on a classic cable locator. The main functions being:

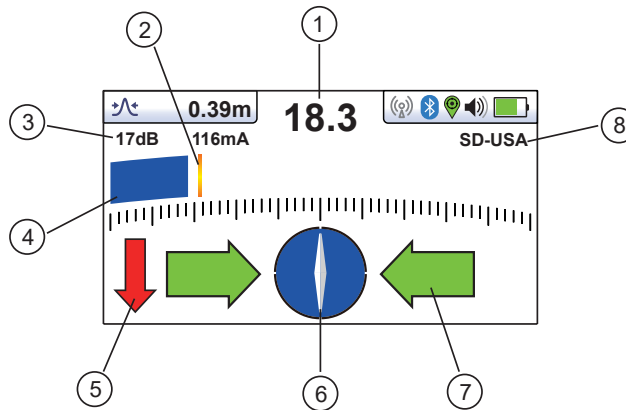

1	Percentage of signal strength (mirrors (4) the bar graph)	5	Signal Direction forward/back arrows (only active with Signal Direction frequencies)
2	Peak level indicator	6	360° Compass line direction indicator (turns blue when aligned with the target line)
3	Gain setting	7	Left/Right direction to target line indicators (when in applicable locate mode)
4	The signal strength bar graph will change color with the level of signal distortion: Green: Low distortion electromagnetic field Blue: Minor distortion in the electromagnetic field Red: Excessive distortion electromagnetic field	8	Frequency selection (flashing frequency indicates frequency selection is not valid for this screen. Choose another frequency)

2.8 Classic Locating Modes (Response)

The vLoc3 series receivers have an array of six antennas, and these can be toggled through different configurations (modes) to provide different responses to the signals radiating from buried utilities. The modes are:

2.8.1 Peak Response Mode

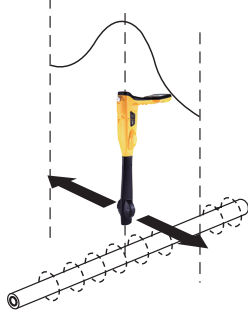

Two horizontal antennas provide a "Peak" or maximum signal response over the buried line.

This is an accurate locating method as both horizontal antennas are used to provide a clearly identifiable "Peak." It is also less prone to the effects of signal distortion.

The Peak Level Indicator on the bar graph indicates the point of the largest signal detected allowing the user to return to this point quickly.

The compass (line direction indicator) aligns itself parallel to the cable (available in Active modes).

2.8.2 Broad Peak Mode

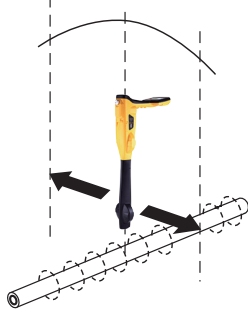

A single horizontal antenna provides a "Peak" or maximum signal response over the buried line.

The result is a less defined peak than the twin horizontal antenna "Peak" mode. This mode is useful in deep lines because using a single antenna can boost the received signal.

The compass (line direction indicator) aligns itself parallel to the cable (available in Active modes).

2.8.3 Null Mode

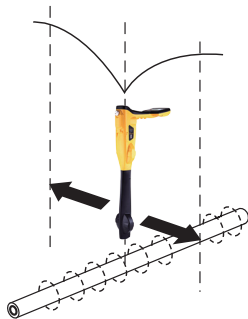

The vertical Null antennas receive a minimum or "Null" response over the buried line.

The Null mode works well in uncongested areas but is more prone to inaccuracies due to the effects of field distortion. This effect can be utilized to detect distorted fields by comparing the "Null Mode" position with the position of the "Peak Mode." If the two positions do not coincide, this indicates possible distortion. The greater the difference the greater the distortion.

Left/right arrows indicate the direction to move the receiver to locate the buried line's position while in the "Null" mode.

The compass (line direction indicator) aligns itself parallel to the direction of the cable (available in Active modes).

2.8.4 Delta Null Mode

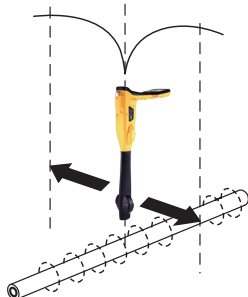

The Delta mode uses dual vertical antennas. The Delta Null has the advantage that it provides a sharper response than the Null mode and is less affected by distorted fields. All other functions are the same as the Null mode.

Delta mode uses dual null antennas to minimize the offset effects of field distortion. This mode tends to be more precise than the Null mode.

2.8.5 Peak with Arrows Mode

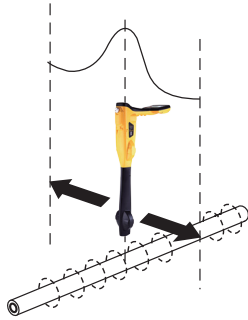

The Peak with Arrows mode operates in the same way as the peak mode. It gives the largest meter deflection when directly over the line. However, the left/right indication arrows are also displayed. The arrows indicate the direction to move the receiver to locate the position of the buried line.

Note:

If the arrows indicated a different position for the cable than the peak bar graph position, this indicates the possibility of a distorted field. Check by taking a depth reading on the ground and then lift the cable locator to a known distance such as 1m (3ft). If the depth does not increase by this amount, it confirms a distorted field and the data should be treated with caution.

2.8.6 Omni Peak Response Mode

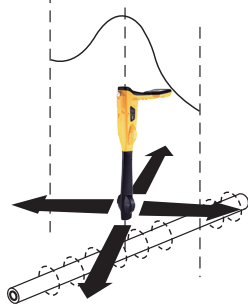

The two double-ended arrows around an icon mean that the line is detectable regardless of locator blade orientation.

It is very useful for quickly checking an area for buried lines using a grid search as one sweep will catch all locatable lines. In the Classic screen, the Omni feature is available in the "Peak" and "Broad peak" modes.

2.8.7 Information Pushbutton (Depth & Current)

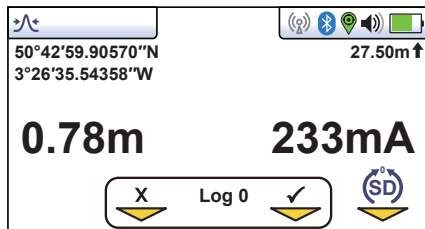

When in a Locate screen, a quick press of the "i" (information) pushbutton will display the depth and signal current.

The top left of the display shows Longitude/Latitude positional information. To the top right is the height above sea level. This information will only appear when the receiver is paired with a GPS module that is receiving a signal.

It is also possible to save the data to the internal memory; see the "Datalogging" section of this manual.



IMPORTANT

When locating a utility depth and current measurements should only be taken with the bottom of the receiver standing on the ground and directly in line with the target utility. When the  Omni direction mode is selected the orientation is not important.

The accuracy of depth and current readings depends on the quality of the radiated signal being located. If the signal is symmetrical (undistorted), the depth reading will be accurate to within 5% of the actual depth. If the signal is distorted, depth readings will be less accurate. When taking depth measurement, always hold the receiver at 90° to the ground.

2.9 Alternative Locate Screens

As previously mentioned, the vLoc3 series receivers have alternative locate screens. The following section describes the operation of these screens. It is left to the user to decide which is the best screen for a particular application.

To scroll through the available screens use a long key press on the Return key.

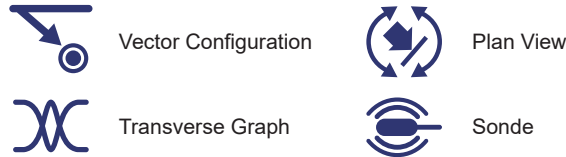

2.9.1 The Vector Configuration Screen

The Vector Configuration Screen shows a cross-sectional view through the ground. A Plan View is also shown to help orientate the user over the line. The Vector Screen is particularly useful where access directly over the line is not possible. The depth and horizontal displacement distances are shown even when not directly over the line.

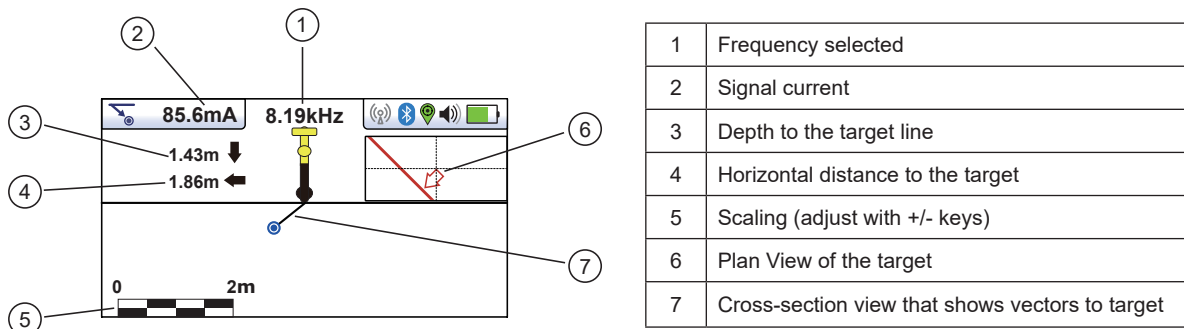

Using the Vector screen

1. Apply the signal to the target line in the usual manner and select the Vector screen using a long press on the Return button until the desired screen appears.
2. Position the locator near the position of the target line. Use the Plan View (6) screen to help guide you toward the target line. You can imagine that the plan view is giving you a view under the ground.
3. Position yourself so that the red target line is pointing forward/back and is in the center of the screen.

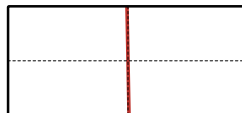

4. If the target is off the screen an arrow will appear on the screen to help direct you to the target line.

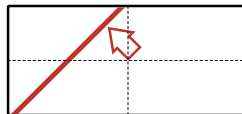

5. The cross-sectional area of the screen will respond as the target is approached. Use the + and – keys to alter the scaling if necessary.
6. There is a black line leading from the locator icon to the target line. The blue dot represents the target. Around the dot is a circle. The size of the circle indicates a confidence factor. The larger the circle, the less confident the indicated position. Generally, the actual position of the line will be within the confidence circle.

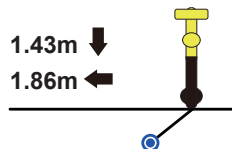

The color of the confidence circle also changes depending on the degree of confidence:
 Green - Low distortion/high confidence.
 Blue - Minor distortion/medium confidence, so please proceed with care.
 Red - Excessive distortion/low confidence. Treat all data and measurements with caution.

7. Notice that vertical and horizontal distances from the target line are displayed.

1.43m ↓
 1.86m ←

These must not be mistaken for the distance diagonally to the target, such information is not displayed. The vertical distance is the true depth from the bottom of the locator. The advantage of this is the target's depth and position can be determined without being directly over the target line. In the event of an obstruction at the measuring point, data can still be gathered by placing the locator on one side of the target.

2.9.2 The Transverse Plot Screen

The Transverse Plot screen is used to analyze the field shape at a particular location which enables the user to better feel for the data's reliability.

Two plots are generated simultaneously.

- Peak response
- Null response

In non-distorted fields the Peak and Null positions should coincide and the shape of the fields should be symmetrical about the centerline. The picture below screen shows a slightly distorted field.

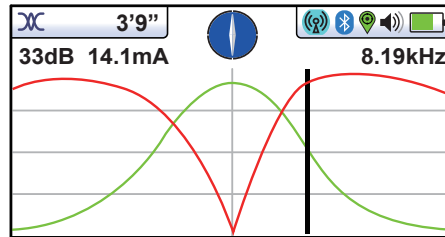

To take a plot, first locate the target using one of the other locate screens. Then select the Transverse screen by a long press of the return button. Repeat this until the Transverse screen appears.

Position yourself to one side of the line so that the field markers are just on the screen. You will see that the lines automatically remove themselves after a set period of a few seconds. Clear the screen by pressing the “-” button. Now walk across the target line at a steady pace until you are on the other side of the target line. Immediately press the “+” button to save the plot on the screen.

It is still possible to walk back over the target locating the line's position in the transverse screen while still retaining the saved screen.

2.9.3 The Plan View Screen

The Plan View screen shows a picture as if you were viewing the line from above ground. When the red line is in the center and pointing forward/back, you are directly over the line and pointing in the line's direction.

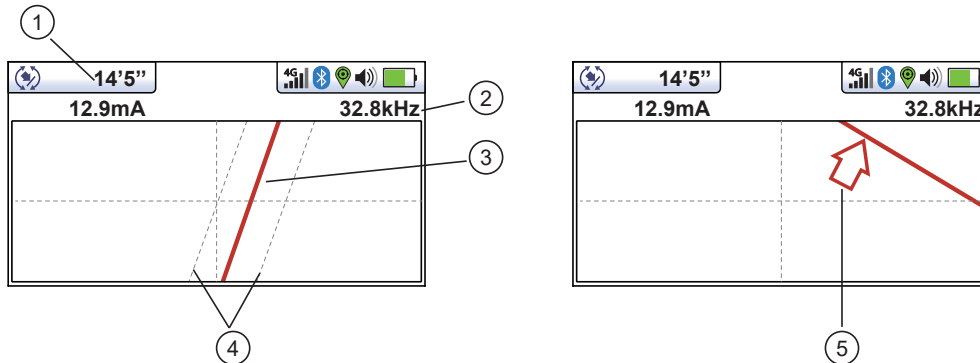

2 vLoc3 Series Receivers

1	Depth and current readings
2	Frequency selected
3	Target line
4	Lines of confidence (the closer these are to the target line indicates more confidence)
5	The Arrow indicates the direction to move toward the line. It only shows when the distance to the target line is far away

Using the Plan View screen

1. Apply the signal to the target line in the usual manner and select the plan view screen by a long press on the Return button until the desired screen appears.
2. Position the locator within the approximate position of the target line. Use the plan view to help guide you toward the target line. You can imagine that the plan view is giving you a view into the ground.
3. Position yourself so the target line is pointing forward/back and is centralized on the screen.

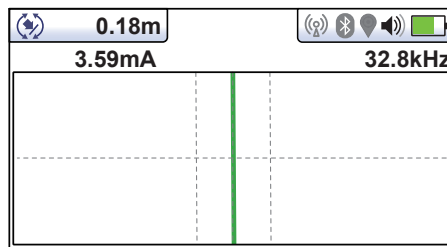

Tram lines on either side of the line indicate an area of confidence. The closer the Tram lines are together the greater the confidence.

In addition to the tram lines the color of the target line also changes depending on the degree of confidence:

Green: - low distortion/high confidence.

Blue: - minor distortion/medium confidence, proceed with care.

Red: - excessive distortion/low confidence. Treat all data and measurements with caution.

4. If the target is off the screen an arrow will appear on the screen to help direct you to the target line.

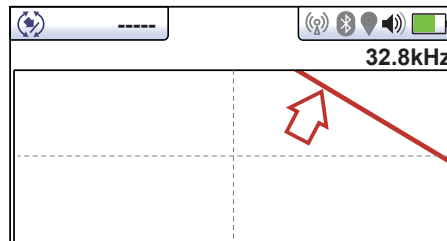

5. As long as the locator is detecting a valid signal the depth or current will be available regardless of locator orientation, i.e., the locator does not need to be aligned with the target line in the forward back orientation. It is recommended that in this mode the current is always displayed as the signal may bleed off onto other services. Regular checks on the signal current, i.e., checking for large changes will ensure the correct line is detected.

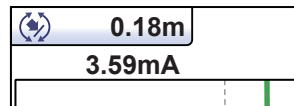

6. A short press on the Info "i" button will display the information screen. More information relating to the information screen is described in a previous section, "Information Pushbutton (Depth & Current)."

3. Using the vLoc3 Series Receivers

3.1 Passive Locating



NOTE

The compass indicator is not active during the passive location.

Passive locating refers to the process of detecting signals that naturally occur on pipes and cables. These tend to fall into two categories, radio signals and power signals.

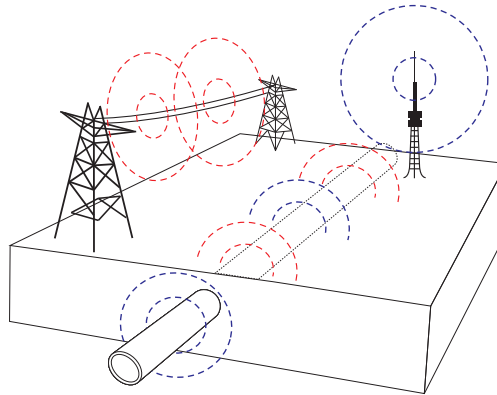

Radio signals - low-frequency radio transmitters create radio signals. These are used for broadcasting and communications and are positioned throughout the world. As the frequencies are very low, the signals tend to penetrate and hug the Earth's curvature. When the signals cross a long conductor such as a pipe or cable, the signals are re-radiated. It is these re-radiated signals that the Radio mode can detect.

Power signals - are created by mains power running in the supply cables. These signals are 50 or 60Hz depending on the country. For instance the UK is 50Hz power while the USA is 60Hz. When electrical power is distributed throughout the network some power finds its way back to the power station via the ground. These stray currents can jump onto pipes and cables and also create power signals. Note that there has to be an electrical current flowing to create a detectable signal. For instance, a live cable that is not in use may not radiate a detectable signal. Also a very well-balanced cable, i.e., the same current flowing in live and neutral, will cancel out and may not create a signal. In practice this is unusual as there are usually enough imbalances in the cable to create a good detectable signal.

3.1.1 Detecting Power Signals

1. Use the "f" button to put the vLoc3 receiver into the Power mode. Notice that the antenna mode indicator will be showing Peak or Omni Peak as these are the only options in the passive modes.

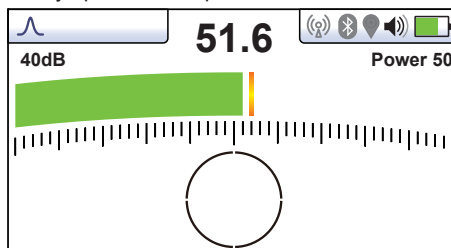

2. Hold the vLoc3 receiver vertically and away from the likely position of other cables or pipes.
3. Adjust the sensitivity using the "+" and "-" buttons so that the bar graph reading is just starting to show some movement. Note that the compass feature is not available in the Power or Radio modes.

3 Using the vLoc3 Series Receivers



NOTE

Note that there will be no sound from the speaker until the meter reading is above approximately 10% of the full scale.

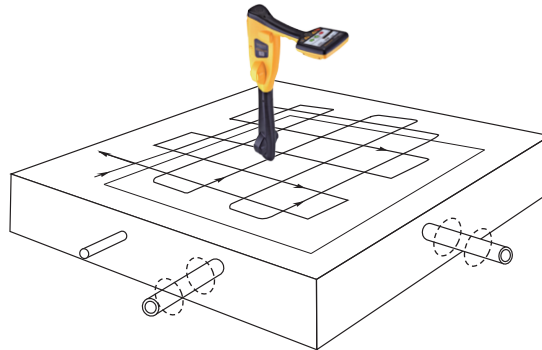

4. Keeping the vLoc3 receiver vertical, walk across the area to be checked keeping the orientation so that the blade is in line with the direction of walking, see the above diagram. If using the Omni Peak mode, the orientation of the locator is not important.
5. Continue in a grid across the area.
6. If the meter reading starts to increase at any time carefully move the locator side to side to detect the maximum signal. Use the peak level indicator to help confirm the correct position.

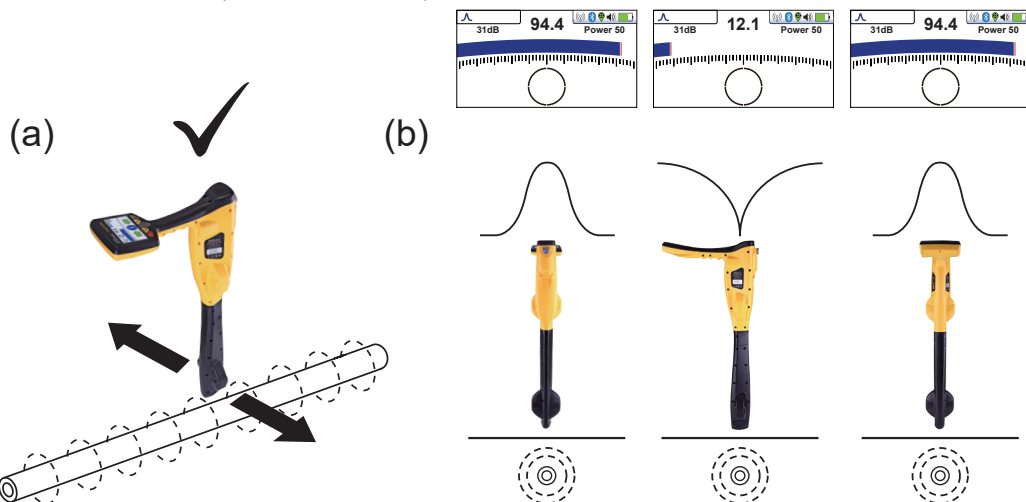

7. Rotate the vLoc3 receiver on its axis to obtain the maximum signal. The vLoc3 receiver is now directly over the line and with the blade across the line. If using the Omni-Peak mode, there will be no change so switch to the Peak mode if the direction is required.
8. The direction can also be found by rotating until the smallest signal is detected. The blade is then in line with the cable/pipe.
9. Continue to locate the line's position at regular intervals until its course is known through the target area.

3.1.2 Detecting Radio Signals

1. Locating radio signals is very similar to detecting power signals as they are both passive signals.
2. Hold the vLoc3 receiver vertically and away from likely positions of cables or pipes.
3. Adjust the sensitivity control so that the bar graph reading is just starting to show some movement. Now follow the procedure described above in the power mode section.

3.2 Active Locating: Applying the Transmitter

Active locating uses a transmitter to apply a precise frequency to a pipe or cable then uses a receiver turned to detect the signal being radiated at that precise frequency. Active location frequencies can be applied by direct connection, signal clamp, or induction (this is further explained in the following sections).

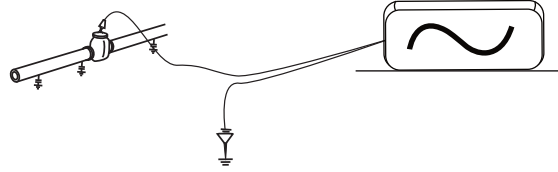

Unlike passive detecting, active locating has the benefit of the operator controlling the signals and can be more specific about what line is detected. Passive signals are also not always present on a line so using active signals ensures more lines are detected.

Choosing the correct frequency depends on the application but as a general rule select low frequencies as these tend to “bleed off” less than higher frequencies. A good general-purpose frequency is 33kHz and is a good starting point if in doubt.

When using Induction or the Signal Clamp, the frequencies available are limited frequencies optimized for the equipment. The full range of frequencies is available in the Direct Connection mode.

For frequencies below 45 kHz authorities such as the FCC allow higher power output to be used; for frequencies of 45 kHz and above power output for this type of equipment is restricted to 1 watt. Therefore more power is available when lower frequencies are used.

To inject a signal requires the use of a transmitter. The transmitter signal can be injected or applied to the target line in a variety of ways.

3.2.1 Direct Connection

This method involves making an electrical connection to the cable or pipe.



WARNING
The direct connection leads are not designed for connection to live cables.



WARNING
Do not touch metal parts of the connection clips when connecting to the line or when the transmitter is on.

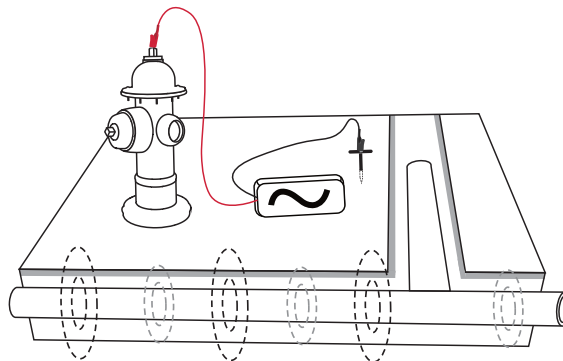

WARNING
Only authorized personnel should make connections to cables.

3 Using the vLoc3 Series Receivers

To make a direct connection, insert the direct connection connector to the transmitter. Insert the ground stake into the ground a few meters perpendicular to the line. Connect the black lead to the ground stake. Next take the red lead and connect to the target line.

Switch on the transmitter by pressing and holding the On/Off button down for a couple of seconds. Select the desired frequency depending on the application. Check for a good connection by either noting the mA output on the LCD or noting the change in tone rate when disconnecting and then reconnecting the red lead.

Always start with low output and increase the output if the received signal is not strong enough. Setting the output to high when it is not required may result in some of the signal bleeding off onto other services and will drain more power than necessary from the battery.

It is sometimes impossible to find a suitable projection to apply the connection clip to a ferrous material. If this is the case use a magnet to contact the line and then clip the red clip to the magnet. A good example of this is to make a connection to a street lighting circuit. Usually it is the practice to connect the sheath of a lighting cable to a street lamp's metallic inspection cover. Making a connection to the inspection plate will energize the cable via the plate and sheath. Usually there is no projection on which to clip so using the magnet on the plate provides a suitable clipping point.

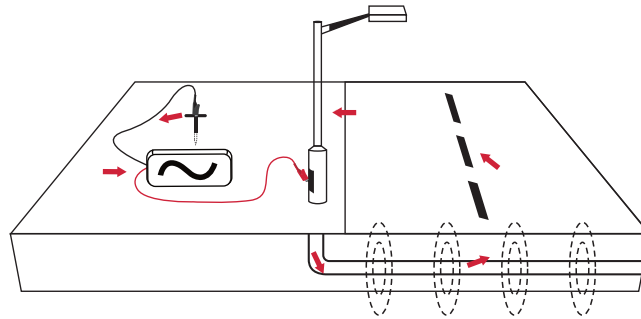

3.2.2 Signal Clamp (for frequencies above 8kHz)

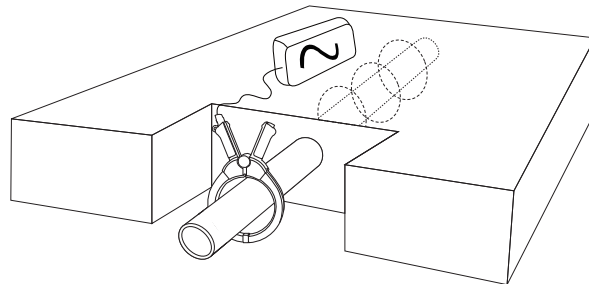

In many situations when it is not possible to make a direct connection to a cable, a signal clamp will provide an efficient and safe method to apply a locate signal.

Note that for best results the cable should be grounded at both ends. The clamp should be fully closed for optimal current induction. A small amount of current will still be induced if the jaws are open.

When clamping around a cable make sure the clamp is placed below the grounding point as shown below.

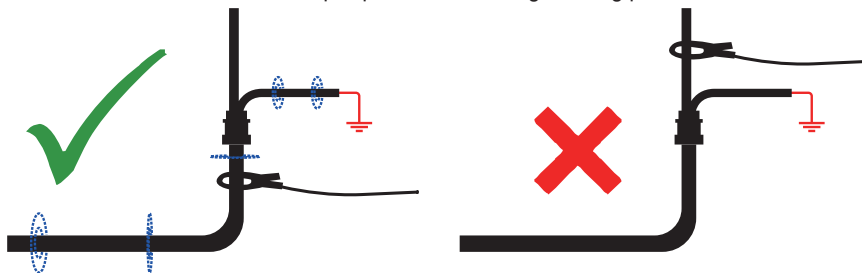

3 Using the vLoc3 Series Receivers

When applying a clamp close to a grounding point where multiple grounds or a grounding bus exists ensure that you place the clamp around the target line and not to the ground bus/other grounds. This will help focus the applied signal on the target line.

Clamp Extension Rod

A useful accessory to the clamp is the extension rod:

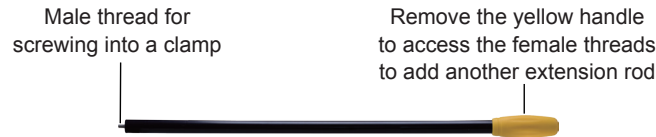

The extension rod is fitted with a 10mm threaded male stud. This male thread screws into the handle of the signal clamp to extend the distance of the clamp. This helps in areas with difficult access such as in manholes or trenches. (not to be used on uninsulated overhead power cables).

The extension rod is fitted with a female thread in the handle. The female thread allows the rods to be joined together to extend the range. To access this thread, slide the yellow handle off the rod.

To operate the clamp jaws when attached to the rod gently pull on the clamp cord which will open the jaws. Release the cable to close them.



WARNING

Always follow the appropriate safety requirements mandated by safety legislation, safety practice, and your company's safety procedures when applying a clamp (coupler) to a cable.



BEWARE that when placing a clamp around cables carrying high current the clamp may vibrate, jump or close violently due to induced current from the target cable.

High voltages can be induced back onto the clamp and be present at the clamp's plug in some situations. Safety practices should be followed at all times when clamping around live target lines!

Always ensure the clamp is connected to the transmitter before clamping around a line.

3.2.3 Induction (for frequencies above 8kHz)

When no direct connection lead or signal clamp is connected the transmitter will automatically start to radiate or induce a signal around the transmitter. These signals will penetrate the ground and couple onto buried lines. The signal will then travel along the line which can be detected with the vLoc3 receiver.

Applying an induction signal to a line.

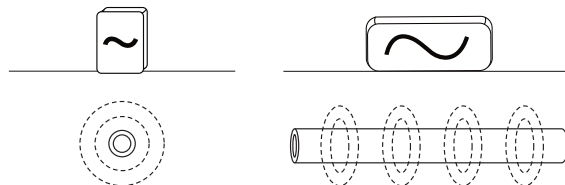

3 Using the vLoc3 Series Receivers

Remove all connections from the output connector. Switch on the transmitter and place it over the suspected position of the line and position it so that it is in line with the target. In the case of the Loc3 series transmitters that will be with the handle pointing along the line.

The induction mode is particularly useful where there is no access to the line, but it should be noted that this is the least efficient method of applying a signal. It is also prone to signals being applied to adjacent lines.

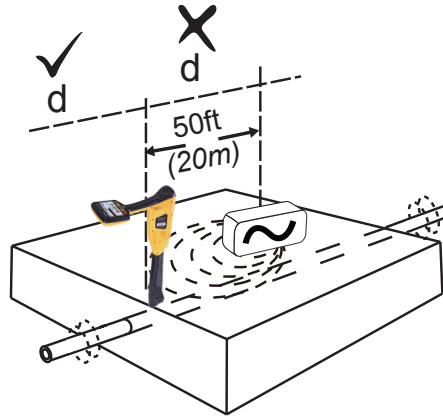

Also note that the signal will radiate out to the sides and below the transmitter. For this reason it is recommended that when applying a signal using the induction method a distance of at least 4.5m (15-feet) is kept from the transmitter when pinpointing or taking depth readings.

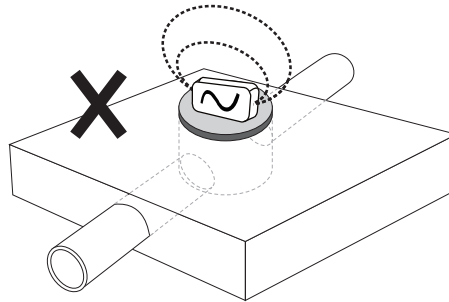

When using the induction mode avoid placing the transmitter over metallic manhole covers. Doing so will severely reduce the transmitter's effectiveness and in extreme cases cause damage to the transmitter's circuitry.

3.3 Locating Active Signals

These instructions assume that the Classic Screen is selected and Peak with Arrows mode is selected for the antenna configuration.

1. With a transmitter, apply an active locate signal to the line.
2. Set the receiver to Peak with Arrows
3. Match the frequency of the receiver to that of the transmitter.

Note that the screen will now show the addition of a compass (line direction indicator). In the presence of a locate signal the compass will align itself parallel to the line being located. The compass helps to ensure that the operator is aware of the direction of the line.

3 Using the vLoc3 Series Receivers

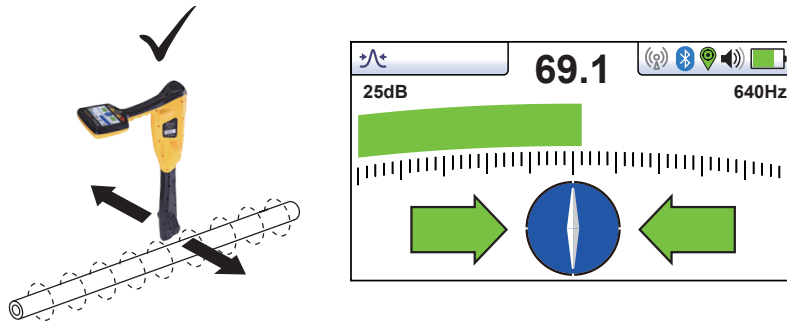

Hold the locator vertically and rotate it on its axis until the compass indicates Forward/Back, as shown above.

Adjust the sensitivity control so that the display indicates approximately 50%. Keeping the vLoc3 receiver vertical move to the side slightly. If the bar graph increases, you are moving toward the line. If it decreases, you are walking away from it. Move toward the line as indicated by the direction arrows until a maximum signal is achieved. It may be necessary to reduce the sensitivity to keep the bar graph on the scale. This is a normal occurrence and should be expected. Try to keep the vLoc3 receiver vertical and avoid swinging it, as this may create false readings.

Move the locator side to side to ensure a maximum signal is detected. Use the peak level indicator to assist.

With the maximum signal found and the compass running Forward/Back the vLoc3 receiver is now directly over the line and exactly across it.

If the signal is not distorted and the maximum signal's position will coincide with the position as indicated by the arrows. If these two positions do not agree it may be because there is signal distortion. Treat the results with caution.

Continue to trace the line to its destination or source.

If you have selected the Omni Peak antenna configuration arrows will not appear on either side of the compass. This is because when in Omni mode the line can be detected from any direction.



Tip
When in a locate screen, pressing and holding the “f” key will bring up the frequency table.

Power 50
Power 60
Radio
491Hz
512Hz
8.19kHz
8KFF
9.82kHz
32.8kHz

Use the “+” and “-” keys to navigate quickly to the desired frequency. Press the “i” key to select a highlighted choice and return to the locate screen.

3.4 Searching (sweeping) an Area in the Peak Mode

Buried utilities may be parallel to each other and frequently they cross the area being searched at various angles and depths.

As the locator antennas response is directional (using the traditional screen), it is important to search the area in the same or similar pattern as shown. This orients the antennas in a way that will locate any signals being radiated from the buried utility.

Once a response is found, trace pinpoint and mark the utility. Searching an area in this way is generally but not exclusively done in the Peak mode using passive locating.

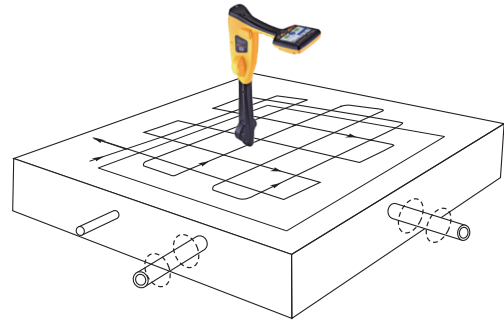

3.5 Searching an Area in the Omni Peak Mode

Searching in the Omni Peak mode is very similar to the Peak mode, except that it is only necessary to sweep an area in one direction. A zig-zag motion is enough rather than a full grid action because the locator will respond to a signal from a line in any direction. It has the benefit of cutting the sweep time in half.

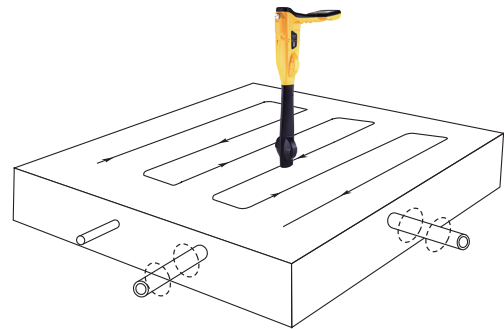

3.6 Tracing a Buried Line

Where possible trace out from the transmitter connection point. Having pinpointed the line, hold the locator vertically and in front of you with the compass line indicator pointing forward/back. Start by moving the locator left to right/right to left over the line. Keep the movement over the center of the line, i.e., the largest meter response, adjusting the gain when necessary. Whenever practical it should be traced to the point that provides additional confirmation of what type of service is being located, i.e. a telephone pedestal, a manhole cover, etc.

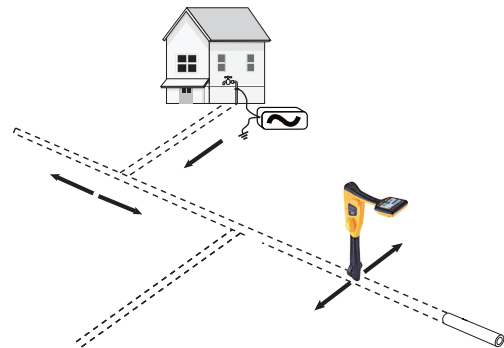

3.7 Depth & Current Measurement

If the depth measurement feature is activated it is possible to take depth measurement estimations. To take a depth measurement first pinpoint the position of the line. Place the vLoc3 receiver's tip on the ground, making sure it is vertical and across the line, i.e., the compass indicating Forward/Back. Momentarily press the "i" button. The screen will change to a screen similar to the one to the right.

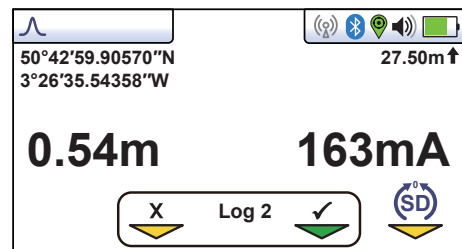

If Omni mode is selected, the locator's orientation is not important, but it is still necessary to pinpoint the line accurately before taking a depth measurement.

3 Using the vLoc3 Series Receivers

When taking a depth reading the signal current value will also be displayed. This feature is useful for confirming that the detected signal is radiating from the correct line. If the signal is bleeding off onto other services these signals will generally be less than that of the originating signal. However, care should be taken as the signal current will gradually reduce over the length of the line. Watching for a sudden drop in current over distance should indicate that either:

1. There is a ground fault on the line which is a shunting signal to ground.
2. There is a Tee off from the mainline.
3. The operator has migrated from the connected line to a line with some signal bled across from the mainline.

3.8 Distorted Fields

Always be aware that you are locating the signals radiating from the buried line. These radiated fields can be distorted by other lines or electromagnetic signals from buried lines. Metallic structures like crash barriers or wire mesh fences can also help to distort signals.

vLoc3 series receivers can detect the presence of possible distortion. The Vector screen has a circle drawn around the target line, which increases in size in the presence of possible distortion. The Plan view screen has "Tram" lines on either side of the calculated position, which moves further from the line as possible distortion is detected.

However, when using the traditional screen the risk of an inaccurate location can be reduced further by doing the following:

- Check to see if other radiated fields are distorting the signal. Locate the cable, first in the Peak mode and then in the Null mode or use the left/right arrows. The two locations should indicate that the cable is in the same place. If they do not, the signal field is distorted, and the depth and current measurement may be inaccurate.

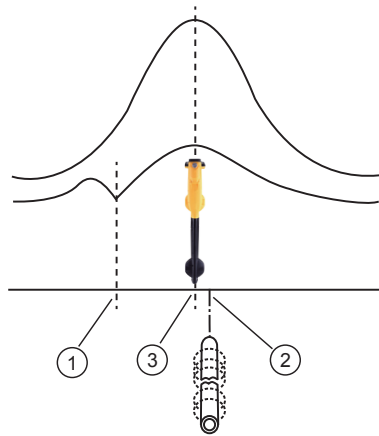

1	Null Position
2	True Position
3	Peak Position

When the Peak and Null positions do not line up

- Measure the buried line's depth by pressing the "i" pushbutton briefly to measure depth and current. The depth should be approximately in line with the "as-built" plans available. If no plans are available, logic would still help assess the situation (for instance, if you are looking for a shallow CCTV distribution cable and the depth indicated is 5ft (1.5m), it should raise a concern).
- Take a depth reading on the ground and then raise the locator approximately 1ft or 0.25m and repeat the depth measurement. The depth should increase by this amount. If not, treat the information with caution.
- A depth reading on congested areas or close to bends or tees may be inaccurate due to distorted fields.

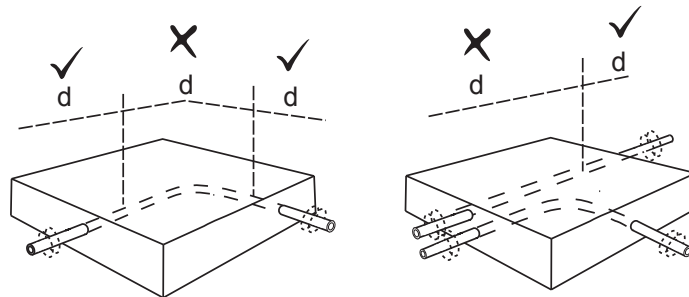

3.9 Sonde Location Mode

A Sonde is typically used for locating non-metallic pipes or ducts or the camera end of a sewer inspection camera. Low-frequency versions (512Hz/640Hz) can transmit through some metallic pipes such as cast iron pipes which is why they are frequently used with sewer inspection cameras.

The Sonde Location mode is a Peak mode which means that the bar graph and audio will grow when approaching the sonde and at their maximum when over the sonde.

Sonde screen:

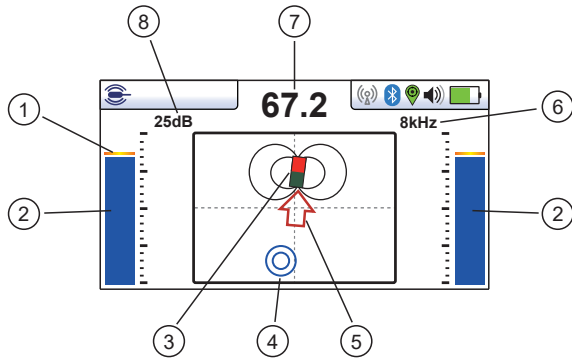

1	Peak signal detector
2	Signal strength bar graph
3	Sonde icon
4	Null point
5	Direction to sonde
6	Frequency selection
7	Numeric signal level (mirrors the bar graph)
8	Gain setting

The Sonde transmitting coil radiates differently than that of a line.

Due to this construction the sonde gives a different “Peak” pattern than when locating a buried utility.

There will be three distinct peaks. A large Peak will be followed by two smaller Peaks on each side of the large one. A Null point will be between each small peak and the large peak. The sonde is located under the center of the “large peak.”

The vLoc3 receivers detect the two “Null” signals and the position of the main “Large Peak.” It uses this information to provide a reliable and efficient method of sonde location.

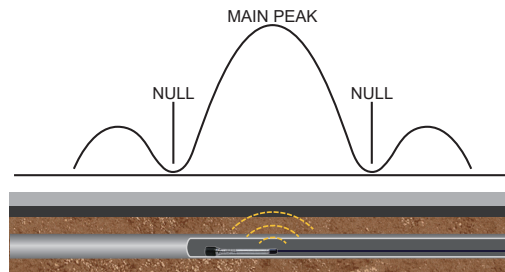

The vLoc3 Sonde Screen will display the **Large Peak as a Sonde icon** and the **Null Points as double blue circles**, as shown in the illustration to the right.

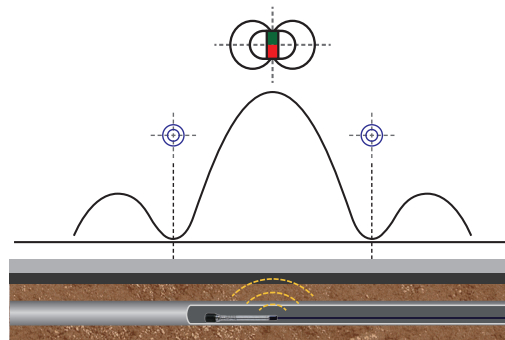

Method

1. Switch on the vLoc3 receiver and use long presses on the Enter key to enter the Sonde screen.
2. Press the “f” key to select the sonde frequency matching the sonde being located.
3. Insert the activated sonde into the pipe. Push the sonde about 10 – 12-feet (3-4m) into the pipe.
4. Hold the locator vertically and stationary with the tip on the ground.
5. When the receiver is within the sondes range, a screen similar to the one below will be seen. On the screen, the arrow will be pointing to the sonde. The bar graphs on either side of the screen are identical and indicate the signal strength. Use the + and – keys to alter the receiver gain to keep the signal within the bar graph's limits.

3 Using the vLoc3 Series Receivers

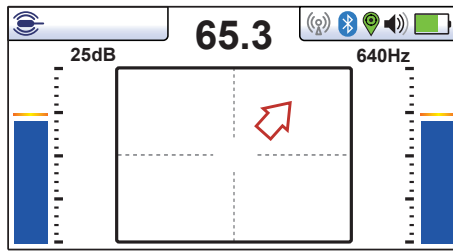

6. If the bar graph is not steady, it will most likely be because the sonde is not within range. In this case, hold the locator at approximately 45 degrees to the ground and rotate the locator around a full 360 degrees around you. Note the strongest signal's direction and walk towards it until the bar graph shows a steady signal. Now revert to step five above.
7. Walk slowly in the direction of the arrow.
8. A double circle will appear on the screen, indicating the position of a null signal. Walk toward it and position it over the crosshairs of the screen. Now rotate the locator so that the arrow is pointing forward.

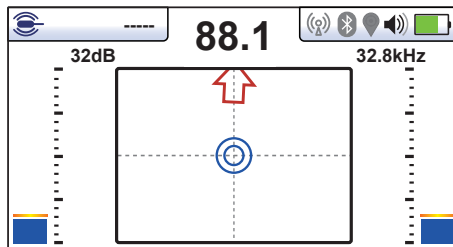

9. Keeping the null indicator on the vertical line walk toward the arrow.
10. A Sonde icon will soon appear. Keeping the locator vertical carry on walking toward the Sonde until it is positioned on the crosshairs. The locator is now directly over the Sonde. The arrow will flip forward and back as the position is crossed.

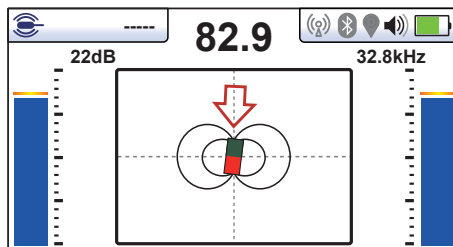

11. Note that it may be necessary to confirm the Sonde position when directly over the Sonde left to right. Do this by moving the locator left to right to identify the strongest signal's position as indicated on the bar graph. At this time the depth of the Sonde will be displayed at the top of the display.
12. Having pinpointed the Sonde position it can now be pushed into a new location and the process repeated. It is advisable to keep the survey intervals too short distances such as six feet (two meters) making locating easier.
13. Pressing the Information key shows the depth measurement and data and data logging capabilities.

3.10 Signal Direction Precision Identification Mode



vLoc3 receivers with the SD option installed will show this SD icon label on the receiver's blade where it meets the yellow upper housing.

Some vLoc3 series of locators contain a feature called Signal Direction or SD. This feature verifies that the line being located is the same line that the transmitter is connected to.

When a transmitter is connected to a target line the signal travels along with it and finds the easiest way to travel back, usually via the ground and ground stake. However, the signal will often travel back along with adjacent cables or pipes offering an easier route.

3 Using the vLoc3 Series Receivers

As a result multiple signals radiate from cables and pipes in the area making it difficult to identify the target line. These return signals are typically traveling in the opposite direction than the applied signal. The Signal Direction feature identifies which direction the signal is flowing and hence the target line.

To use the signal direction mode:

- Connect the transmitter to the target line using a direct connection only.

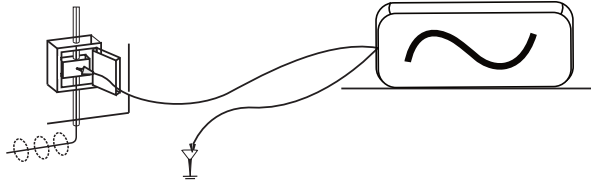

- Turn the transmitter and receiver on and set both to:
 - SD-USA – if in North America or any territory where the power system is 60Hz.
 - SD-EUR – if in Europe or any territory where the power system is 50Hz.
- Locate the cable. The receiver may or may not be flashing the “SD” Forward/Back arrows icon
- A flashing SD arrow indicates that the unit needs to be synchronized with the transmitter. Even if the arrow is not flashing it is always good practice to synchronize the system at the beginning of a survey to ensure reliable results and maximize the next synchronization point’s distance.
- To synchronize the receiver to the transmitter at the beginning of a survey pinpoint the line very close to the transmitter – be sure that it is the correct line. Then, standing facing away from where the transmitter is attached, press the “i” pushbutton. The unit will display the information screen showing the depth of line, signal current, and an “SD” icon positioned over the return pushbutton. Pressing the return pushbutton will synchronize the system and return the unit to the locate screen. The green forward arrow will light and not be flashing indicating the receiver is locked onto the signal. The system is now synchronized.

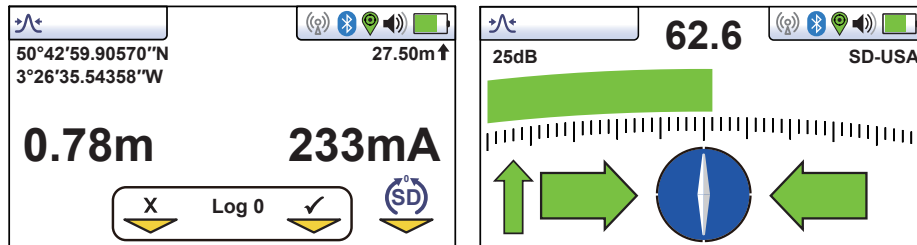

- Proceed to locate, trace and pinpoint as required ensuring at all times the green forward arrow is illuminated. If the red backward arrow illuminates at any time this indicates that the wrong line is being located.

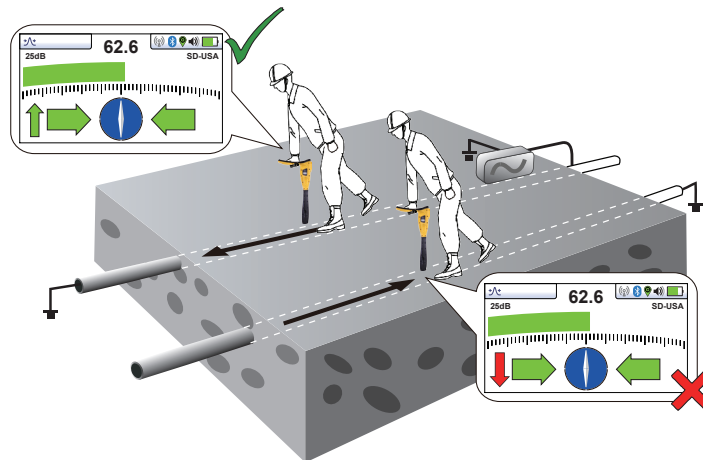

- At some point you may find that the SD arrow starts to flash this is indicating that synchronization with the transmitter has deteriorated and a reset is required.

3 Using the vLoc3 Series Receivers

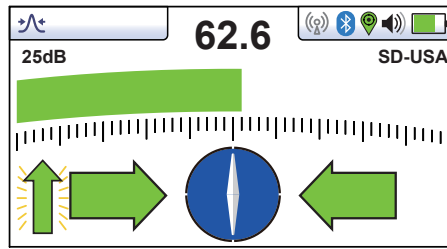

- Re-trace your line back to a point where a solid signal direction is obtained. Precisely pinpoint the line and stand with your back to the direction of the transmitter as you did when you initiated the original sync and press the “i” pushbutton, then the enter/return pushbutton to re-sync with the transmitter signal.

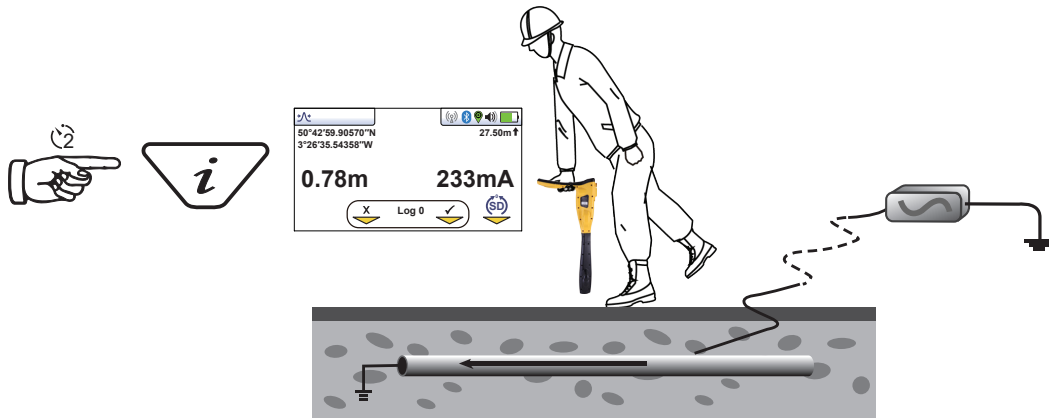

- Continue to locate and pinpoint.



NOTE

If several lines are commonly bonded, the signal direction will carry through to the other lines. This is useful for locating multiple line installations.

However, be aware that if a non-target line is commonly bonded to the target line, that line will also appear “in sync” with the target line.

When performing a reset, take care to ensure that you have not strayed from the target line.

4. vLoc3-ML Receiver

The vLoc3-ML Locator and vLoc3-MLA Locator Adapter accessory both detect the presence of buried EMS markers. The Marker Modes and Locate Screens are identical.

4.1 Serial Number and Software Revisions

Always quote your receiver and accessory model number, serial number, and software revision number when requesting product support. They can be found as follows:



vLoc3-ML Receiver



vLoc3-MLA
Marker Locator Adapter

1	Model & Serial Number
---	-----------------------



NOTE

Software Revision Number: On both the receiver and transmitter the software revision number is displayed on the LCD during the startup sequence or found in the About section of the user menu.



Receivers with the **SD** option installed will show this icon label on the blade where it meets the yellow upper housing.



Receivers with the **Tx-Link** option installed will show this icon label on the blade where it meets the yellow upper housing.

Transmitters with the **Tx-Link** option installed will show this icon label on the upper corner of the housing.

4.2 vLoc3-ML Receiver

Passive markers often mark the route or points of interest along non-metallic utilities such as fiber optic cables/plastic water and gas lines. The vLoc3-ML is designed to locate the position of these markers.



vLoc3-ML What's in the Box

4.3 Locating Markers with the vLoc3-ML & vLoc3-MLA

The operation of the vLoc3-ML and vLoc3-MLA are exactly the same with the exception of Depth Measurement. Depth measurement with the vLoc3-MLA is covered in section 4.4.1.1 of this manual.

When not being used as a standard cable locator, the vLoc3 series receivers can be operated in two other configurations:

- Dedicated marker locator
- Dual cable locator and marker locator

4.3.1 Operating the Receiver



NOTE

Line depth and current measurements are not available in the Dual locate mode. Switch to a line locate mode to view depth and current on the line.

4.3.1.1 Dedicated Marker Mode



Long press on the  button to enter the Dedicated Marker Mode.



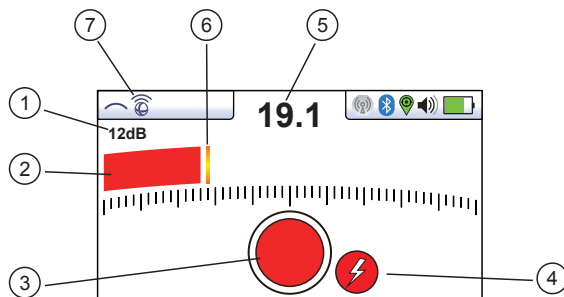

In this configuration the unit is dedicated to locating markers. The screen of the vLoc3-MLA will look similar to the illustration below:

The Dedicated Marker Screen



1	Bar graph gain setting
2	The signal strength from Marker used for pinpointing its position
3	Marker detection ball
4	Marker type
5	The numeric value of the bar graph
6	Peak level indicator
7	Marker icon indicating marker detection active



Note that the ball icon  only is illuminated indicating that the dedicated configuration is selected. The color of the bar graph and marker detection ball is also set to the marker's color. If the line icon   is illuminated with the ball icon the Dual configuration is activated. Dual mode is described later in this manual.

Either use the  pushbutton to select the marker type that is to be located or use a long press on the  button to enter the user menu. Select the "Marker Type" which will then cause the display to show the complete range of markers available together with their operating frequencies. Use the "+" and "-" keys to scroll up and down through the options. Press the  button to make your selection and then the  button to exit this screen.

Menu		
About	←	
Speaker Volume	🔊	
Sound Configuration	←	
Backlight	Auto	
Frequency	←	
Locate Perspective	←	
Marker Type	←	

Power (169.8kHz)
Water (145.7kHz)
Sanitary (121.6kHz)
Telephone (101.4kHz)
Gas (83kHz)
CATV (77kHz)
Non-Potable Water (66.35kHz)
Power Europe (134kHz)



Tip
Pressing and holding the  button will shortcut you to the frequency screen. Exit by pressing the  button.

Detecting a Marker in the Dedicated Mode

Switch on the locator and select the correct marker frequency.

Sweep the area where the marker is to be located. Use a slow deliberate arm sweeping motion moving forward making sure no area is missed.

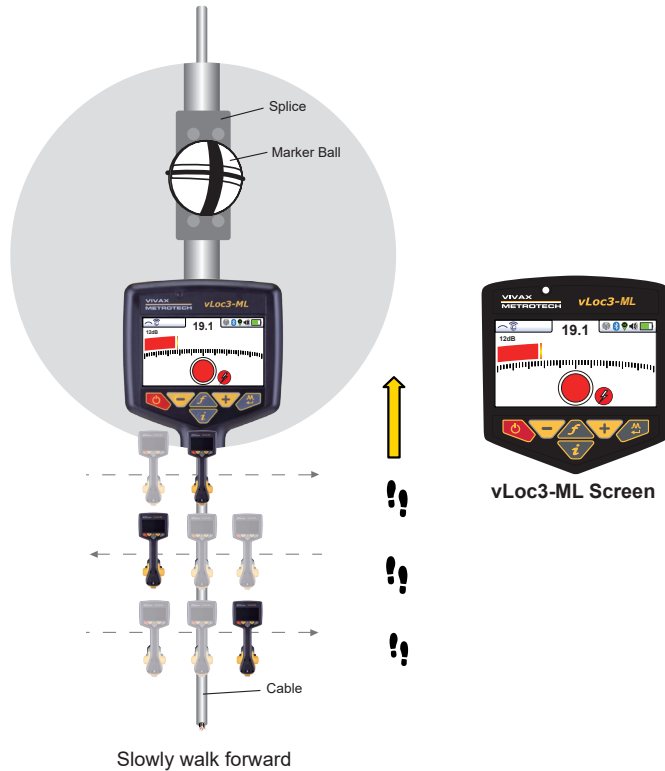

When in range of the marker an audio tone is heard from the speaker. The icon in the center of the display (2) will fill along with the audio tone.

Move the locator forward and back, left and right, until the largest signal is detected. Note the bar graph (1) will also respond. Use the "+" and "-" pushbuttons to keep the signal on the scale. The bar graph should be used to pinpoint the position of the marker.





4.3.1.2 Dual Configuration

In this configuration, the unit can trace an energized cable or pipe while simultaneously looking for markers. For example, if a cable has markers indicating splices or T joints' position, the cable can be traced; when a marker is approached, the unit will respond, indicating its position.

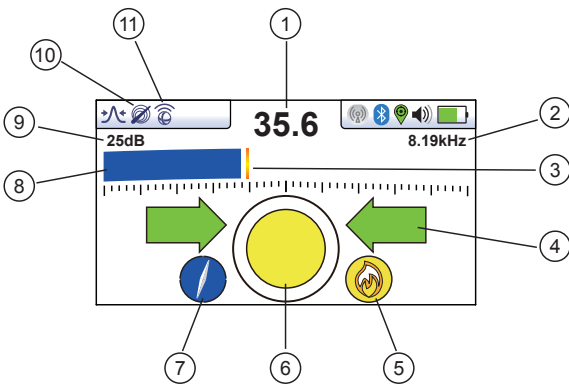



Enter the dual configuration, as previously described. The following icons should be displayed in the top left screen  . The locator screens will look similar to the illustrations below.





The Dual Mode Screen

1	The numeric value of line signal strength from the energized line
2	Line locate frequency selected
3	Peak level indicator
4	Line left / right indicator
5	Marker type, graphic
6	Marker signal strength
7	Compass line direction indicator
8	Bar graph signal level from Line
9	Line locate gain setting
10	 Line icon indicating line locate is active
11	 Marker icon indicating marker detection active

Select the marker type to be detected. When in the Dual Configuration selecting the marker type is done through the user menu. Press and hold the  button and use the "+" "-" keys to scroll to the marker type option. Press the enter key to access the available marker types. Scroll as before to the desired marker, and press the return button to select.

Menu		   	
Speaker volume	←		
Sonde Configuration	⊞		
Backlight	←		
Frequency	Medium		
Locate Perspective	←		
Marker Type	←		
Language	English		

Power (169.8kHz)
Water (145.7kHz)
Sanitary (121.6kHz)
Telephone (101.4kHz)
Gas (83kHz)
CATV (77kHz)
Non-Potable Water (66.35kHz)

Note that both icons   are now illuminated, indicating that dual configuration is activated. Energize the cable with an active signal as instructed in this manual.

Select the antenna configuration by using the  pushbutton. Note that the left/right arrows indicate the cable position and **not** the marker position.

Use the  pushbutton to match the transmitter frequency (Some active frequencies may not be available in the dual-mode as they may affect the marker locate function.) Use the locator to identify the position of the cable or pipe. Trace the line using the same technique as a standard vLoc3 series locator. The bar graph indicates the signal strength from the cable. The bar graph is always colored blue in the Dual configuration mode and does **not** indicate signal distortion or marker type.

In the Dual configuration mode, the "+" and "-" pushbuttons alter the bar graph's sensitivity. It is not necessary to alter the sensitivity to the marker locate function. The sound is from the line position. In Dual configuration, the marker has no sound associated with it.

As a marker is approached, the marker locate icon will start to fill up. Move the locator forward and back, left and right, to obtain the largest signal. If pinpointing is required, select the dedicated configuration and use the bar graph to pinpoint the exact position.

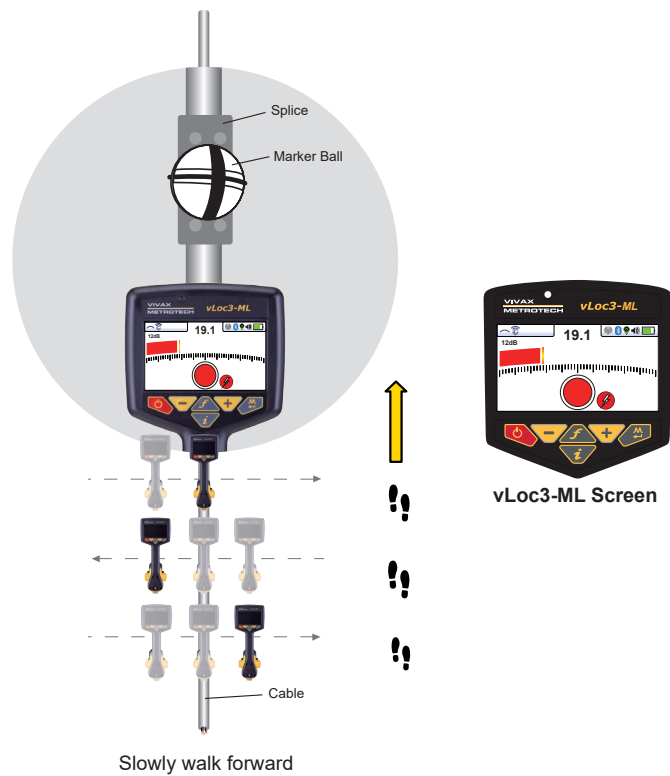

4.4 vLoc3-MLA

The vLoc3-MLA accessory attaches to the base of the vLoc3-Pro, vLoc3-5000, vLoc3-9800, or vLoc3-XLF receivers to locate passive markers buried above non-metallic services or points of interest. This manual covers all three mentioned receivers as the functions are the same across all three. Still, the locator screen will be slightly different in appearance.

4.4.1 Set-up the vLoc3-MLA

Attaching the vLoc3-MLA Accessory

1. Take the vLoc3-MLA accessory and push-fit it onto the end of the vLoc3 series receiver blade. Ensure it clicks to lock into place.
2. Now take the 8-pin ninety-degree connector and plug it into the accessory socket on the vLoc3 receiver.



4 vLoc3-ML Receiver

3. Push the provided cable retainer over the blade and cable so that the cable is secured.



Removing the vLoc3-MLA Accessory

1. To remove the MLA accessory first remove the cable retainer by pulling it over the vLoc3 receiver blade. Then unplug the accessory from the vLoc3 receiver accessory socket

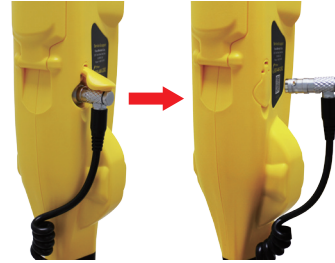

2. To remove the accessory it is necessary to simultaneously push the two yellow retaining buttons positioned on both sides of the accessory. It is best to use the thumb and middle finger to do this. With the buttons depressed pull the accessory from the blade of the vLoc3 receiver.



4.4.1.1 Operation of the vLoc3-MLA

The operation of the vLoc3-MLA is the same as the vLoc3-ML receiver with the exception of **Depth Measurement**. The following section will cover depth measurements with the vLoc3-MLA.

4.4.1.2 Marker Depth Estimation with the vLoc3-MLA



Note

It is only possible to take depth measurement of a marker when in the dedicated mode.

Procedure:

1. Switch the receiver to the **Dedicated Marker** mode.
2. Pinpoint the position of the marker as previously described.
3. Position the locator on the ground directly over the marker.

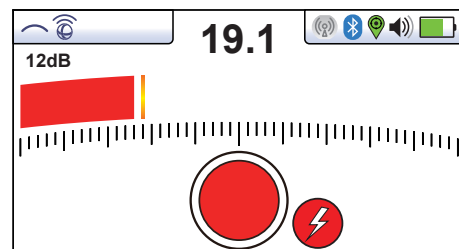

4 vLoc3-ML Receiver

4. Press the  button. The screen will change to a similar screen as the illustration shown on the right.



5. When prompted (when the animation starts) lift the receiver straight up eight inches/20cm.



6. Raise the locator eight inches/20cm and press the  button as indicated by the animation.



7. The depth estimation will be displayed similar to the one shown.

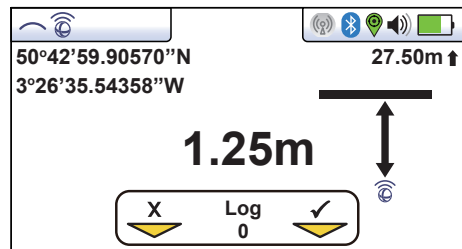

NOTE
If the marker signal is not valid because it is very shallow or the signal is weak because the marker is very deep, the depth indicator will be replaced by dashes.



TIP
The depth readings' accuracy will depend mainly on the eight inches/20cm lift accuracy. Taking care to lift the distance accurately will yield the best results.

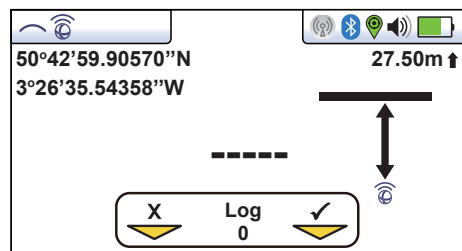

5. Data Logging

The vLoc3 series receivers have four gigabytes of internal memory that can be used to store locator data. Four gigabytes of space can save many thousands of records.

The records are user-initiated and stored by the user whenever the “+” button is pressed when in the “Information” screen. Data can be stored relating to a standard locate or relating to any of the receiver accessories. (apart from the Remote antenna accessory).

Each time a self-test routine is run, the results are automatically recorded in the equipment. Warnings and Alarms are also automatically recorded.

1. To store a record, first, locate a point of interest.

Hold the vLoc3 stationary over the target and press the “i” pushbutton.

In the depth and current screen, press the “+” pushbutton to save the data.

The “Log” number indicates the number of records stored. To exit the screen without logging the data, press the “-” button.

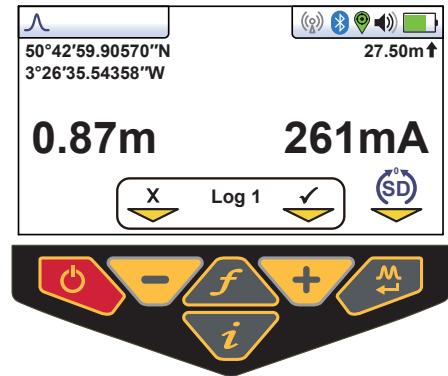

If the GPS function is enabled, the GPS coordinates will also be displayed and attached to any saved file. For more information on Data logging and GPS, see section 4.2.

2. When the save button is pressed, the Log number will increment, and the arrow below the check sign will turn green, indicating that the data has been stored successfully

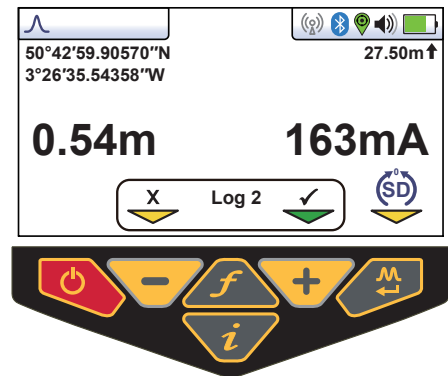

3. The screen will then automatically revert to the locate or accessory screen.

The data logs can also be deleted from the Info screen.

4. From the Info screen, press and hold the “-” key.

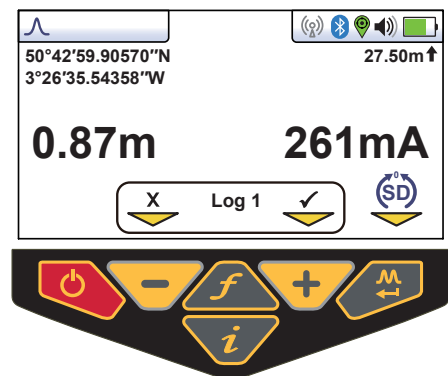

5 Data Logging

5. Press the "+" key to confirm.

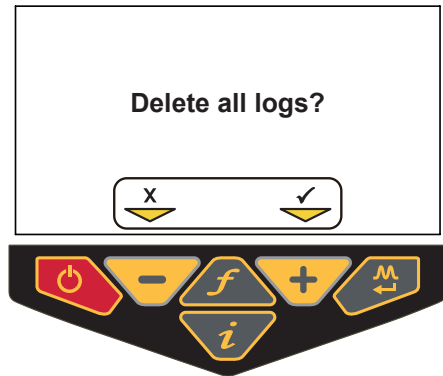

6. Press the "-" key to delete or the "+" key to cancel.

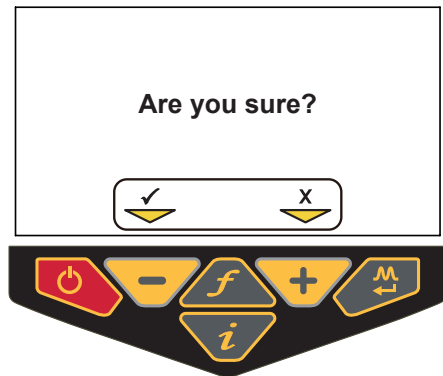

7. After the deletions are complete, the vLoc3 will return to the locate/accessory screen.

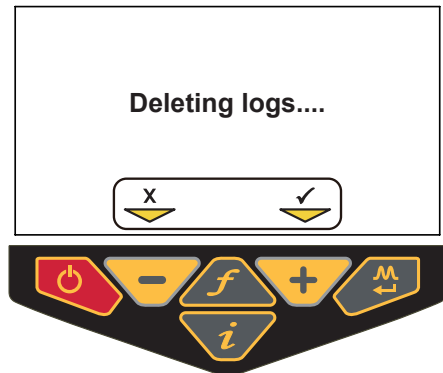

5.1 Bluetooth Bluetooth®

As an option the vLoc3 series receivers can be upgraded by the user with a Bluetooth module to communicate with external GPS modules or Dataloggers.

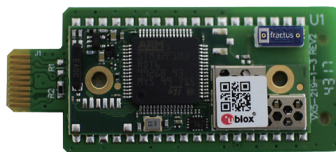

vLoc3 Series Bluetooth Module

5.1.1 Fitting the Bluetooth Module

1. Turn the receiver off and remove the battery pack.
2. With a small cross-head screwdriver remove the two screws of the module cover and remove the cover.



Remove screws



Remove cover

3. The slot on the left is for the Bluetooth module. The slot on the right is not active and for future developments. Carefully slide the Bluetooth module into the slot and press with your thumb to secure it in the slot.



Install the Bluetooth module into the left slot

4. Replace the cover and tighten the two retaining screws being careful not to overtighten.
5. Install the receiver battery and switch on the unit. After a few seconds a black Bluetooth icon should appear showing that the module is fitted.
6. If the Bluetooth icon is grey this means the GPS option is not fitted or incorrectly fitted.
7. The Bluetooth module can communicate with external devices that are also Bluetooth enabled. Generally Bluetooth devices fall into two categories of high and low power devices. The vLoc3 Bluetooth module is compatible with low-power devices.

5.2 Pairing with external GPS or Dataloggers

First check that a Bluetooth module is installed in the vLoc3 receiver. A grey color GPS icon on the status bar shows that no Bluetooth module is installed. A Black GPS icon indicates that the Bluetooth module is installed.

Bluetooth pairing with external devices.

1. Switch on the external device.
2. Switch on the vLoc3 series receivers and enter the user setup menu by a long press on the “i” button.
3. Use the “+” and “-” keys to scroll to and select Bluetooth Pairing.
4. Press the Enter key.
5. Press the Enter key to start a Bluetooth search for external devices.
6. A list of available devices will be shown.
7. Scroll to the desired external device and press the Enter key.
8. Double press the “i” button to return to the main screen.

After a few seconds the Bluetooth icon should turn blue indicating the device has paired successfully.

The unit will remember the pairing even after switching off. However the unit can only remember one unit at a time so if the unit is paired with another device the settings will be replaced.

GPS (Global Positioning System)/GNSS (Global Navigation Satellite System)

The vLoc3 series receivers can utilize location data from an external GPS/GNSS. The vLoc3 receiver needs to be paired with an external device (see the previous section on Bluetooth devices).

Once paired with an external device the vLoc3 receiver will await valid GPS data from the external device. The GPS icon will turn green when a valid GPS signal is detected. It can take from a few seconds to a few minutes depending on the device and whether it is doing a “cold” or “hot” start.



5.3 Transferring Data from the vLoc3 Receiver to a Computer



MyLocator3

One method of transferring data is to use the vLoc3 Series Configurator Tool, "**MyLocator3**". This free desktop program can be downloaded from the Vivax-Metrotech website.



VMMMap

Another method to access the locator data is by using the **VMMMap App**, which will store all the locator's data in the web portal. See our website under "Apps" to learn more.



TIP

To view Google kml files, the Google Earth app is needed.
This free app can be found by doing a google search for Google Earth.

5.3.1 MyLocator3

This section describes the user operation of the MyLocator3 PC application.

MyLocator3 is a desktop PC application capable of downloading code and configuring the vLoc3 series of locators.

The first part of this document, Basic Operation describes usage not requiring a USB security dongle. The second part of this manual, Advanced Features describes usage requiring a security dongle.

MyLocator3 is a free downloadable App available at www.vivax-metrotech.com in the Apps section.

Follow the instructions to download and install the application. A "MyLocator3" icon will appear on the computer desktop after the app is installed.

Connect your vLoc3 series receivers to the computer via the mini-USB connector which can be found under the battery cover flap. Launch MyLocator3 by double clicking on the icon.

5.3.2 MyLocator3's Basic Operation

MyLocator3 operation not requiring a USB security dongle.

5.3.2.1 Updates Page

When a locator is first connected to the PC the Updates Page will be displayed. The updates page will show the locator variant type, the locator serial number and the running firmware version in the upper left-hand boxes. The upper right-hand box will show information about the MyLocator3 PC application.

Clicking on the Clock symbol sets the locator time to UTC. To check local and UTC hover over the Icon and the times will be displayed to the right flashing alternately.

Checking the "Auto Load Config" box ensures the locator's configuration setting is automatically uploaded to the MyLocator3 app when the locator is connected.

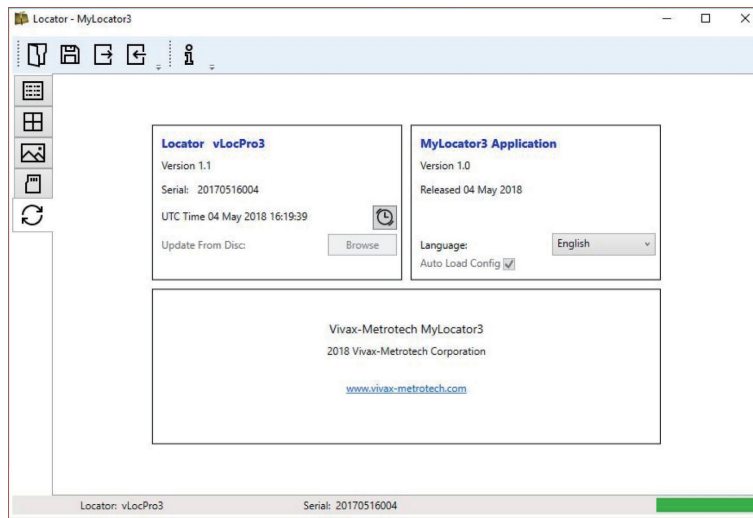

The MyLocator3 startpage

MyLocator3 can be viewed in several language options. Click on the pull-down menu to select the desired option.

5.3.2.2 Application Update

Every time the MyLocator3 Application is started, its version number is checked against the latest version available on the Vivax-Metrotech server. The user is notified if an update is available as in the below illustration. This feature will only be available if the computer is connected to the internet.

Clicking on the Update Now button will download the latest version from the Vivax-Metrotech server which the user can install.

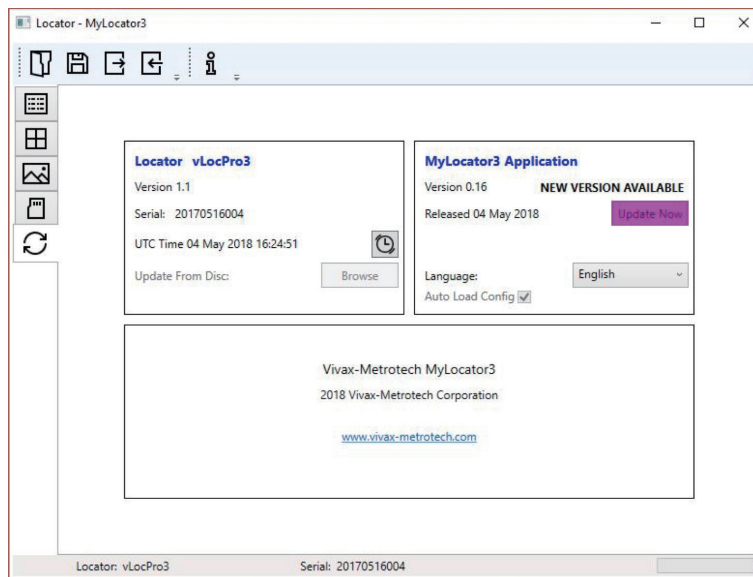

5.3.2.3 Locator Firmware update

Each time a locator is connected to the PC, its firmware version is checked against the latest version available on the Vivax-Metrotech server and the user is notified if an update is available, as shown below. This feature will only be available if the computer is connected to the internet.

Clicking on the Update Now button will fetch the latest version from the server and then download it to the locator.

The Update From Disc feature will only be available if a suitable dongle is attached to the PC. This feature allows the user to install older versions of firmware stored on the computer although it is advised that only the latest version of firmware is used.

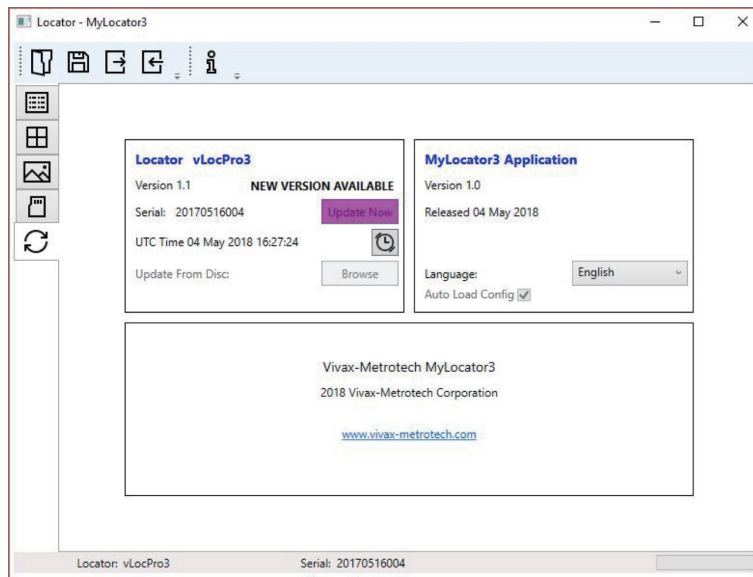





5.3.3 Toolbar

The vLoc3 series receivers can be configured so that features can be switched on or off. Doing this enables the user to tailor the instrument to meet their application's needs while keeping the user interface uncluttered. The toolbar at the top of the screen enables the user to create configurations.

The application toolbar looks like this:  New.vmcfg MyLocator3



	Opens an existing configuration file (*.vmcfg).		Reads the configuration from the connected locator.
	Saves the configuration to a file.		Displays information about MyLocator3.
	Writes the configuration to the connected locator.		

5.3.4 Data Logging

Clicking on the Data Logging tab will display information about the state of the attached locator's data log contents. The data log contents can be stepped through by using the controls on the right-hand side. The user can upload a selection of logs from the locator to the PC using the upper right-hand side controls. The data in the data log can be configured before exporting. The parameters that can be set are:

- Distance units
- Date format
- Time format, i.e., UTC or local time

Files may be exported and saved locally as .csv, .bin, .kml or .shp files and examined later. The default filename is based on the serial number of the connected locator but can be changed during the saving process.



Tip

If it is only required to export a portion of the log (for instance, a survey on a particular day), use the data log scroll facility at the bottom left of the display to scroll through to the start date and time. Note the log number and then scroll to the end date and time and note this log number. Use these numbers to enter the From - To numbers in the display's top right when exporting. Doing so will help to keep the exported data to a manageable size.

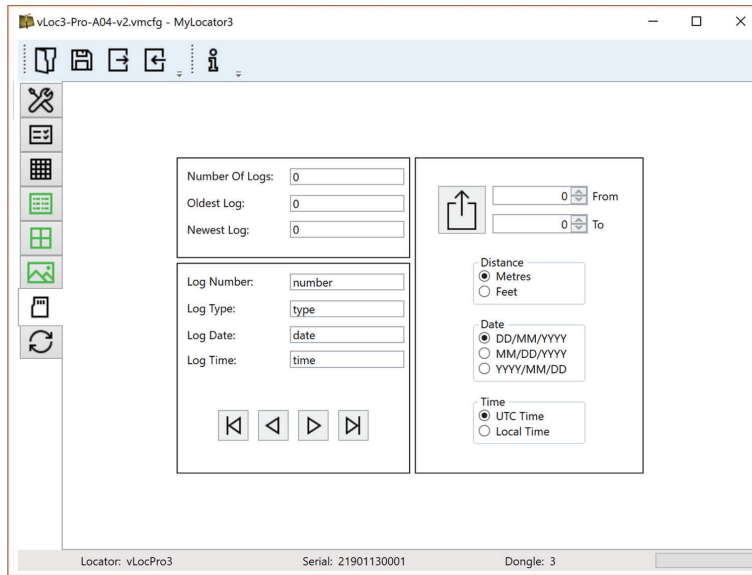

Data Log management screen

Before exporting the data use the **Log Type** dropdown tab to select the type of data required. Options are:

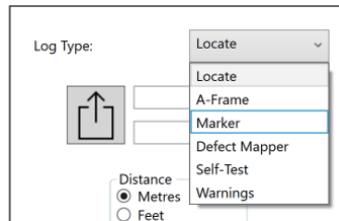

Log Type dropdown list

5.3.5 *Splash Screen*

In this section, an image can be loaded as a splash screen when the locator is turned on. The locator has an LCD screen with a resolution of 480 by 272 pixels. The image loaded into MyLocator3 will be scaled to fit the width of the screen. If the scaled image height is less than the LCD height, then the image is centered vertically, and white bars are used as padding. If the scaled image height is greater than the LCD height, then the image can be re-positioned vertically by clicking and dragging the left mouse button anywhere on the image.

To insert your startup screen, first, click on the “Open” button. Then browse your files to select the picture required as the startup screen. The application is compatible with file formats .jpg, .bmp, .png and .gif.

The startup screen will be displayed in the application.

The Download button can be used to set the splash screen immediately, or the image can be sent to the locator along with the rest of the configuration by pressing the Write Configuration button.

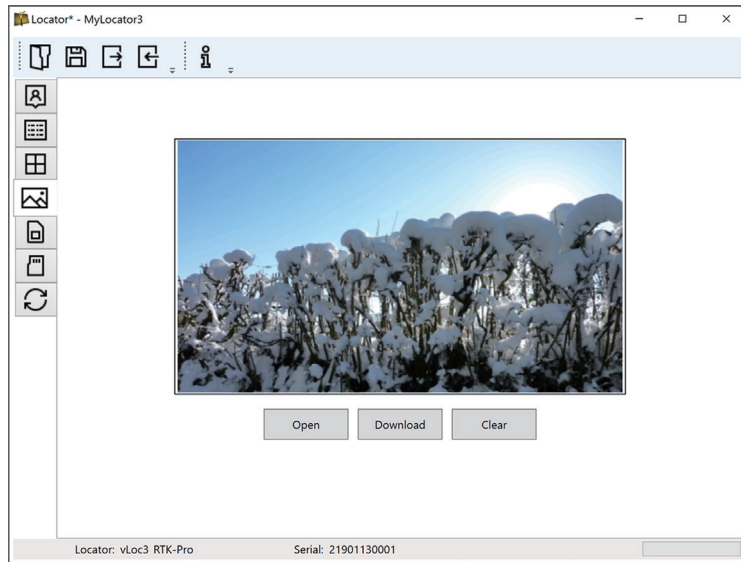

The Splashscreen download area

To remove a startup screen and revert to the default Vivax-Metrotech screen, click on the “Clear” button and download the cleared screen.

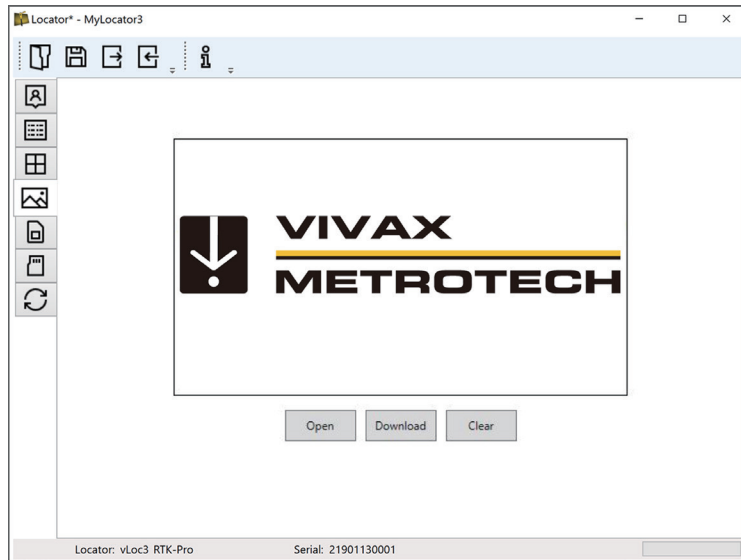

The default factory loaded splash screen

5.3.6 Frequencies Page

The “Frequencies” page allows the user to select which frequencies and modes are available when the locator's F-key is pressed and which frequencies appear on the locator's menu.

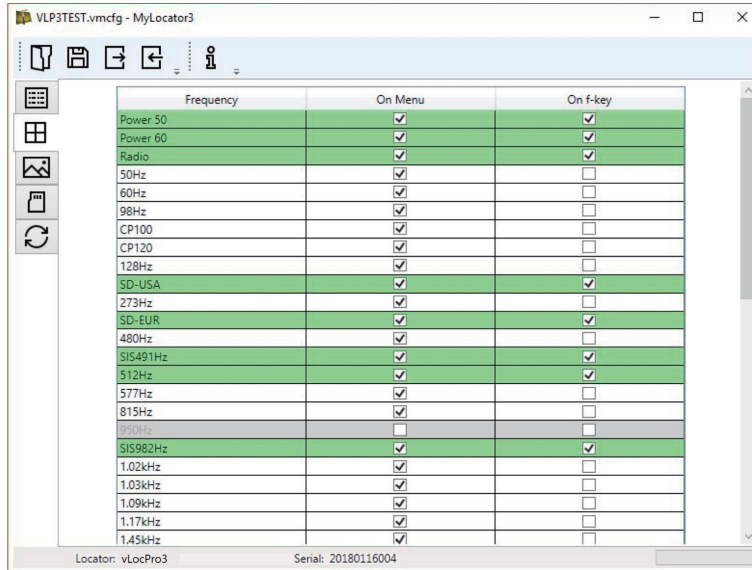

The Frequency page list

5.3.7 Menu Settings

The “Menu Settings” page gives the user control over which menu items appear on the locator and the menu item's initial setting when the locator is first used after configuration.

The menu items with a right-pointing arrow  can be expanded to reveal additional sub-menu items.

If the “On-Menu” item is ticked, then the item will appear on the locator menu. The item displayed in the “Setting” column will be the initial locator setting after configuration. If the “Setting” value is not selected, then the locator setting will be unchanged.

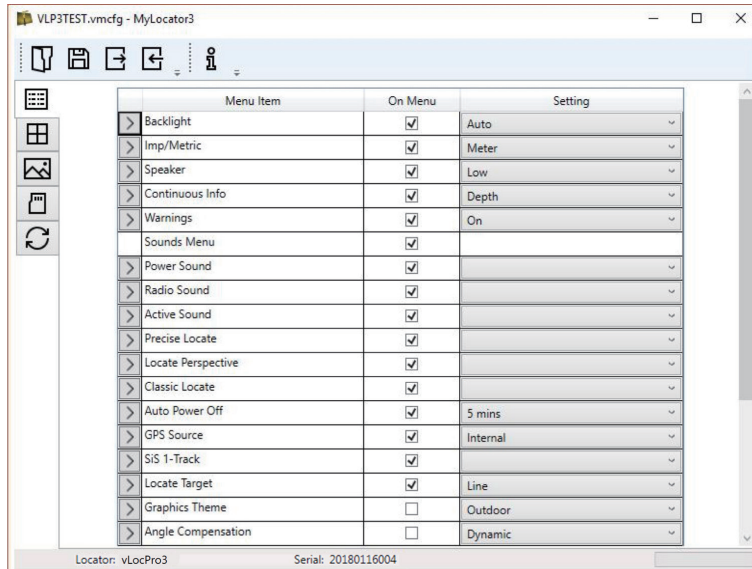

Menu settings

5.3.8 Advanced Features

The Advanced Features are available to those users in possession of a USB security dongle. If a dongle is attached to the PC, its level will be displayed on the MyLocator3 status bar.

Three levels of security come with the dongle. Level one is for the end-user supervisors, level two for Vivax-Metrotech's distributors, repair centers, managers, and level three for Vivax-Metrotech use only.

5.3.8.1 Supervisor Lockouts

This feature is available to anyone with a dongle (contact Vivax-Metrotech to purchase a dongle). When a dongle is connected to your computer via a standard USB socket, the icons for the "Splash Screen" page, "Frequencies" page and the "Menu Settings" page will change color to green. This color indicates the page is unlocked.



Levels of Dongle security

1. End-user supervisors
2. Vivax-Metrotech distributors, repair centers, and managers

The Splash Screen page, Frequencies page, and Menu Settings page can be individually locked by double-clicking on their page tab icon. If a page is locked, a user can only access it with an appropriate security dongle. Doing so will prevent unauthorized users from changing protected locator items. i.e., the "Splash Screen" can be locked to prevent the user from changing it.

The page tab icon will change color from green to amber.

To unlock a tab with the dongle connected, double click on the tab to unlock.

6. The Loc3 Series Transmitters

This section of the manual covers the 5-watt, 10-watt and 25-watt Transmitters.

6.1 Loc3 Series Transmitter Overview

The Loc3 series transmitters are rugged portable transmitters powered by Li-ion rechargeable li-ion batteries or alkaline "D" cells.

5 and 10-Watt Transmitters



1	Loc3 series transmitter
2	Ground stake
3	Direct connection lead
4	D cell alkaline batteries 5-watt = x 8, 10-watt = x 12
5	Alkaline battery tray
6	Mini-USB lead

25-Watt Transmitter



1	Loc3-25Tx Transmitter
2	Li-ion battery tray
3	Carry bag
4	AC/DC Adapter, Loc3-25Tx
5	Direct connection lead, Loc3-25Tx
6	Ground stake
7	Mini-USB lead

6.2 The Transmitter Display

5 and 10-Watt Transmitter Display

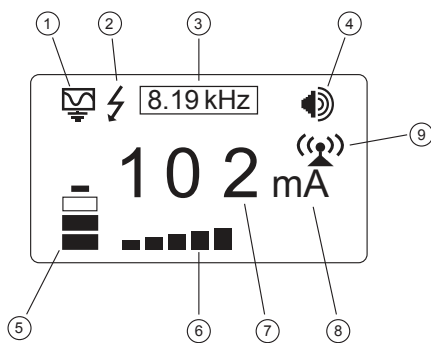

1	Mode indication icon	6	Output step bar graph
2	High Voltage Warning*	7	Digital readout (mA, volts, ohms)
3	Active frequency	8	Units (mA, volts, ohms)
4	Speaker level	9	Tx-Link Status Blinking icon = Tx-Link is not paired Solid icon = Tx-Link is active and linked to the transmitter
5	Battery status		

25-Watt Transmitter Display

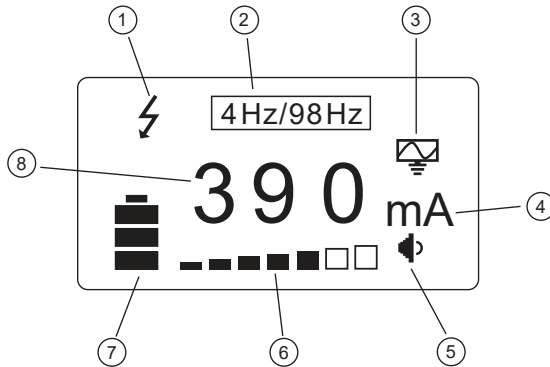

1	High Voltage Warning*
2	Active frequency
3	Mode indication icon
4	Units (mA, volts, ohms)
5	Speaker level
6	Output step bar graph
7	Battery level or DC Input icon
8	Digital readout (mA, volts, ohms)

***Output Protect Warning**

The transmitter checks the line when connected. Output protected against accidental momentary connection to up to 230V AC (RMS), it will display the high voltage warning icon and not allow the transmitter to operate. In addition, the transmitter is protected by a 4A/250V fuse in the event of excessive voltage or voltage spikes on the line.

6.3 Pushbuttons

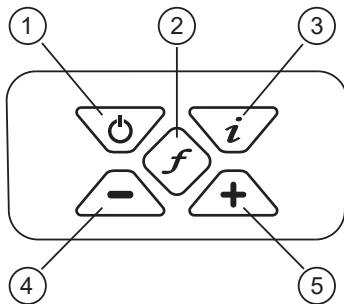

1	On/Off button
2	Frequency selector
3	Information (Volume, Volts, Ohms, Multi-frequencies LCD Contrast, Receiver Link, Frequency menu and About screen)
4	Output decrease/Navigate through the menu
5	Output increase/Navigate through the menu

6.3.1 Transmitter Information Pushbuttons

Press the "i" button to access the transmitter settings and menu.	
Use the "+" and "-" buttons to navigate the settings and menus.	
Use the "f" button to make selections. An X will appear for selected items.	

5 and 10-Watt Transmitter Menu Structure

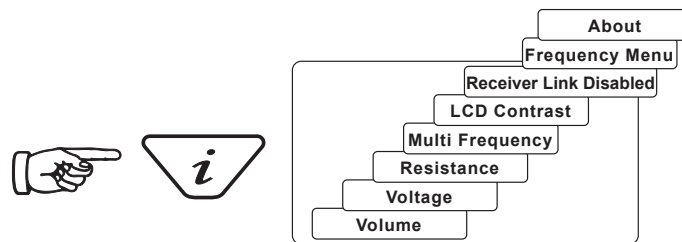

25-Watt Transmitter Menu Structure

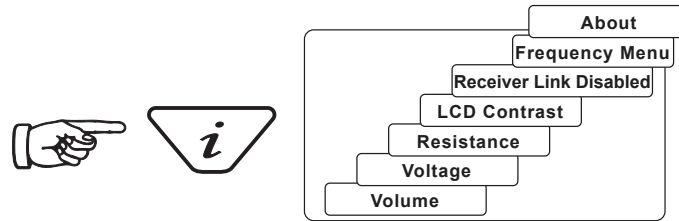

When the “i” pushbutton is pressed the display will show the volume level. Use the + and - pushbuttons to increase, reduce or turn the speaker off. (off-low-medium-high).

Keep pressing the “i” pushbutton, and the display can be toggled to show “voltage,” “resistance,” or other functions as shown in the illustration above. The display indicates mA as the default and volts or ohms when selected.



NOTE
The number of “i” button presses and available sub-menus will vary with the transmitter's mode.

6.3.2 Transmitter Connections Block

5-Watt and 10-Watt Connection Block

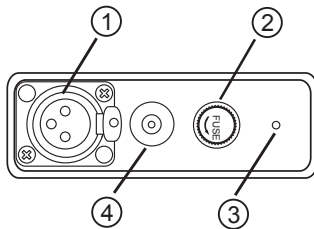

1	Output connection, 3-pin XLR
2	Fuse holder - Output protection (1.6A/250V Fuse)
3	Speaker
4	Battery charging & DC input socket

25-Watt Connection Block

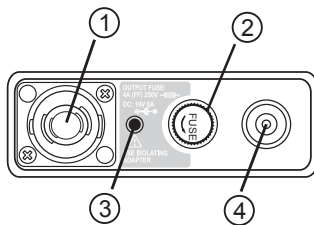

1	Output connection, speakON®
2	Fuse holder - Output protection (4A/250V Fuse)
3	Speaker
4	Battery charging & DC input socket

All connections to the transmitter are made through the connection block.

6.4 Transmitter Batteries – Li-ion and Alkaline

5 and 10-Watt Transmitters - The 5-watt transmitter uses 8 x D cell alkaline batteries, while the 10-watt uses 12 x D cells.

25-Watt Transmitter - The 25-watt transmitter ships with a custom Li-ion battery tray with a charger and power cable. An optional 12 X D Cell Alkaline battery tray can be used with the 25-watt transmitter, but the output will be limited to 10-watts.

On all transmitters the battery status is shown on the transmitter's LCD. The letters “LP” will appear when the battery status reaches only one bar. At this battery level, the max output current and power are limited.

The LED on the charger will show a red light indicating that the charge cycle is in progress. When the batteries are fully charged, the LED will change to green.

Follow the instructions detailed in the General Safety & Care Information section of this document. Dispose of batteries following your company's practice and environmental standards the prevailing laws or recognized best practice. Always dispose of batteries responsibly.



NOTE

The 25-watt transmitter ships with the Li-ion battery tray. An optional alkaline tray can be used with the 25-watt transmitter but the power output will be limited to 10-watts.



WARNING

Use only Vivax-Metrotech recommended charger.
Do not attempt to replace the rechargeable batteries or remove battery covers.
 Return to Vivax-Metrotech or a Vivax-Metrotech approved service center for replacement.

6.5 Charging the Transmitter Battery Tray

The rechargeable battery tray can be charged while attached to the transmitter or on its own. The battery condition (status) is displayed on the transmitter's display.

1. Connect the charger to the charging socket on the transmitter's side or directly into the battery tray's charging socket.
2. The LED on the charger will glow red while charging and turn green when fully charged.

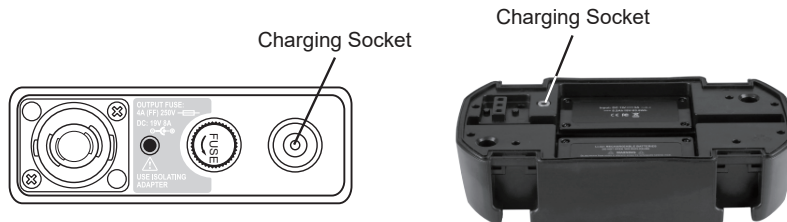

Plug the charger into the charging socket on the side of the transmitter or directly into the battery tray

Battery Charger - is supplied as standard equipment with the 25-watt transmitter.



Battery Charger - is supplied with the optional Li-ion battery tray.



Optional 12-volt DC Power Lead - this 30ft/90m lead can be used to power the transmitter when connected to a target line at high output levels for extended periods. It will not charge the transmitter battery.



WARNING

Only use a charger supplied by Vivax-Metrotech Corp. Using non-approved chargers may result in damage to the equipment or overheating/explosion.



NOTE

The rechargeable tray cannot be charged from a 12V DC source.

Follow instructions detailed in the General Safety & Care Information section of this manual. Only use the battery charger supplied as using an unapproved charger may damage the battery pack and may cause overheating.

6.6 Removing and Installing the Battery Tray

These procedures apply to both the Alkaline and Rechargeable battery tray.

Removing the battery tray



1. Reach under the catch and pull to unlock.



2. Lift up the catch and repeat for all four catches.



3. Lift the transmitter base from the battery tray.

Installing the battery tray



The battery tray and transmitter base have matching aligning post, contact pins and socket.

Aligning the contact pins into their receptacles will assure that the contact pin will mate and not get damaged.



1. Align the aligning post and lower the transmitter base into the battery tray.



2. Press down on the locking catch until it clicks, and locks in place. Rotate the transmitter locking all the latches.

6.7 Transmitter Modes



WARNING

Always connect the transmitter to the target line following your company's procedures. These operations should only be performed by authorized personnel. Always make connections before switching on the unit. Turn the transmitter off before disconnecting.



NOTE

When the 25-watt transmitter is powered on without connection leads, a "NO CONNECTION" message will appear. Power off the transmitter and insert the connection leads, and proceed with power up.

NO CONNECTION



25-Watt Transmitter (Only)

6.7.1 Direct Connection Mode

The **Direct Connection** mode is automatically selected by plugging a connection lead into the output socket. An icon confirming the direct connection mode is shown on the display. The wave in the icon fluctuates when the transmitter is operating. The direct connection lead consists of two colored cables with clips and covers. The red clip must be connected to the conductor being located, the black clip to a suitable ground such as the ground stake provided with the transmitter.

A good connection is indicated by a change in the beep rate from the speaker and the current reading on the display.

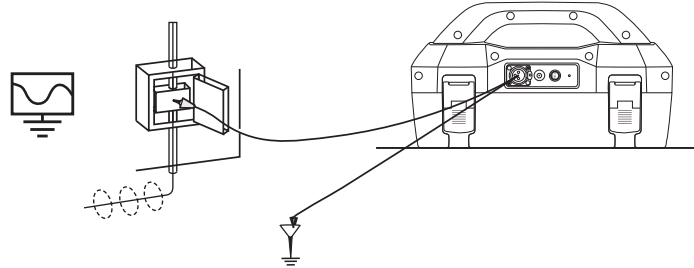

Wherever a direct connection can be safely made without the risk of injury, damage to the customer's plant, or the transmitter, it is the best way of applying the transmitter's signal.

The positioning of the ground connection can also influence the degree of coupling experienced. Ground connections generally should not be made to other pipes or cables or above ground metallic structures such as wire fences. In general, the lower the frequency is, the further the signal will travel, and the less signal-coupling will occur. The most common frequencies used for direct connection are between 512Hz/640Hz and 8kHz.

Regulations in many countries require that power output is limited above specific frequencies. The Loc3 series 5-watt, 10-watt, and 25-watt transmitters enable frequencies below 45kHz to be transmitted using as much as 5-watts, 10-watts or 25-watt output, depending on your transmitter, but frequencies over 45kHz are restricted to 1-watt. Using direct connection and the higher power at the low frequencies helps significantly in achieving greater location distances. Direct connections should not be made to cables carrying greater than 25V (or as your safety practices allow). The transmitter is protected (250V fuse) from stray currents that may exist on the target line.

6.7.2 Clamp Mode

The transmitter signal clamp is a precise way to apply the locate signal. Clamps are generally used when it is impossible to access the conductor to make a direct connection, but there is access to place the clamp around the cable. Clamps are also used when it is not safe to connect because the target cable is live carrying electricity.

The clamp is a specialized inductive device (sometimes known as a toroid or coupler). All clamps are optimized to work at specific frequencies. In most cases, clamps are designed to be used at frequencies generally between 8kHz and 9.82kHz. The transmitter will only allow the selection of a suitable range of frequencies for your clamp.

Plugging a Vivax-Metrotech clamp into the output socket will place the transmitter into the "Clamp" mode. An icon confirming this is shown on the display and will flash when the transmitter is transmitting.

When using the clamp, no ground connection is needed.

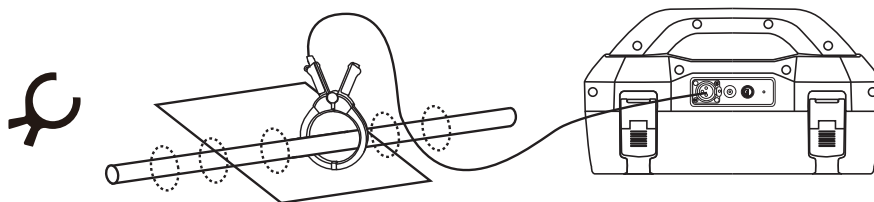

WARNING

When applying the clamp to cables that carry electricity – be sure to follow your company's safety instructions and procedures. Beware that if applied around a high voltage cable – that cable may induce a current in the clamp, causing it to snap shut or jump quite dramatically – always apply clamps carefully.

6.7.3 Induction Mode – 5 and 10-Watt Transmitters Only

The 5 and 10-watt transmitters use an internal antenna to induce a locating frequency onto the target utility. The Induction mode is automatically selected if no connection accessories are plugged into the “output socket.” An icon indicating the “Induction” mode will show on the display. The icon flashes when the transmitter is transmitting. In order to generate successful induction, the transmitter should be positioned over and with the handle in line with the target line.

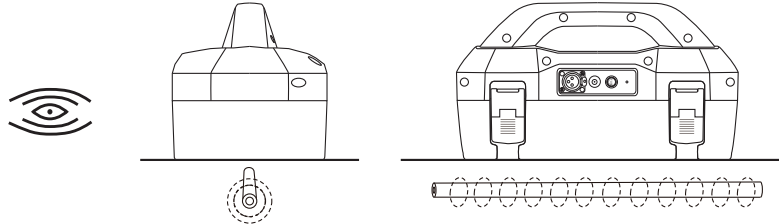

“Induction” mode is generally used when no access is available to make a direct connection or a clamp connection. When using induction, likely, the signal being induced onto the target line will also be induced onto other lines in the area and onto above-ground features such as wire fences. This can influence the accuracy of the location, depth, and current measurements. “Induction” mode is also the least efficient way of applying the transmitting signal to the target line. The distance located with the “Induction” mode is generally much less than that achieved with a direct connection or clamp connection. The “Induction” mode is only available from 8kHz and above.

Induction frequencies are available based on the user selection. See section 6.8.2 for information relating to the “Most Used Frequencies (Frequency Selection) Feature” to add and remove frequencies from the favorite frequencies list.



NOTE
For accurate location and depth measurement, the locator receiver should be used no closer than 66ft (20m) from the transmitter.

6.8 Transmitter Frequencies

The Loc3 series transmitters are supplied with a predefined set of transmitting frequencies. The factory will preset the most commonly used frequencies. Additional frequencies are available to be selected in the frequencies list.

6.8.1 Frequencies and Maximum Power Output

5 and 10-Watt Transmitters

Frequencies power outputs	Loc3-5Tx	Loc3-10Tx
Direct connection 10-watt:	-	98Hz-45kHz
Direct connection 5-watt:	98Hz-45kHz	-
Direct connection 1-watt:	>45kHz-200kHz	>45kHz- 200kHz

Clamp Connection: Available frequencies between 8.19 kHz and 200 kHz

Induction Frequency: Multiple induction frequencies between 8.19kHz and 200kHz

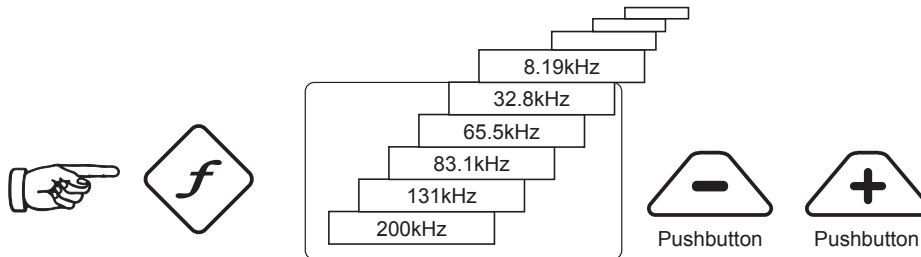

25-Watt Transmitter

Frequencies power outputs

Direct connection 25-watt:

Loc3-25Tx

32Hz - 9.82kHz

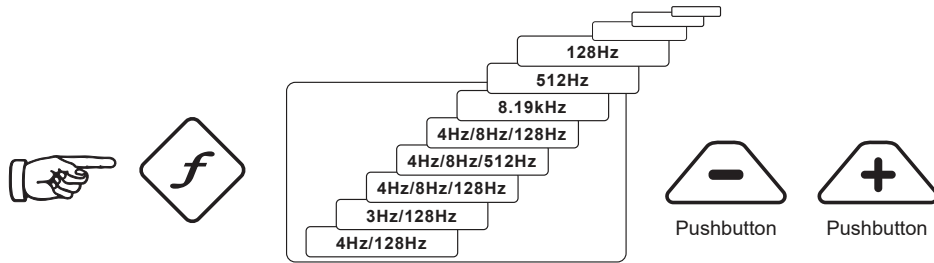

As with most manufacturers, signal clamps are tuned to specific frequencies and **will not** work over the complete range of frequencies.

Frequencies are selected by pressing the “f” pushbutton, which toggles through the frequencies available in the current mode's available frequencies. The frequency is automatically selected if you don't toggle past it within two seconds.

NOTE



The output current is shown in large characters on the display. To increase or reduce the current output, press “+” or “-.” The vertical bar graph at the bottom of the display indicates which of the seven current output steps is being used. If the transmitter can supply the requested current, the bar will turn black. If the bar does not turn black, improving the ground connections or wetting the ground where the earth stake is positioned may help. However, it may not achieve the current setting requested because the line's impedance is too high for this setting. If this happens, it is best to select a lower setting with a black bar, ensuring a stable output.

The impedance of the target line will limit the current being transmitted; therefore, it is not unusual to increase the output level but see no increase in the currently displayed. This is not a fault with the transmitter.

The transmitter will always revert to first level output when switched on as a power-saving feature. In most circumstances, this output level is sufficient. Increasing the output power unnecessarily will reduce battery life. All other settings remain the same as the last setting used.

6.8.2 Most Used Frequencies (Frequency Selection) Feature

This feature allows the operator to choose the most used frequencies from a list of frequencies. Once these frequencies are selected in the main menu, the user can scroll through them by pressing the “f” pushbutton. The user can add or remove frequencies from the above list by following the below procedure. The maximum number of frequencies that can be activated in the most used frequencies list is 12.

The advantage of this feature is the user can work with only their preferred frequencies rather than having a more extensive list of frequencies to scroll through.

Enter the Frequency Menu:

1. Press the “i” pushbutton four to six times (based on the mode that the transmitter is in) until reaching the “Frequency menu” sub-menu.

In Direct Connection mode

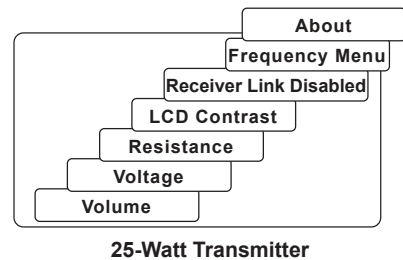
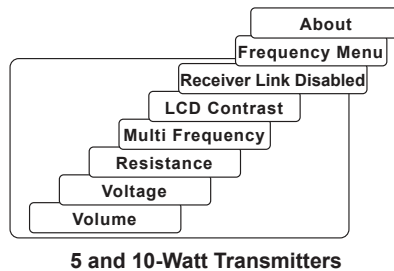

In SD mode

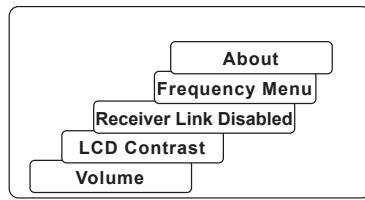

5 and 10-Watt Transmitters

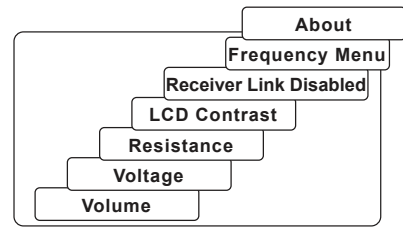

25-Watt Transmitter

In Clamp mode

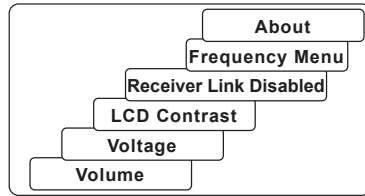

5 and 10-Watt Transmitters

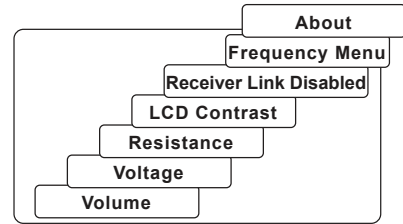

25-Watt Transmitter

- The screen will show a list of frequencies available, with the central one in a box

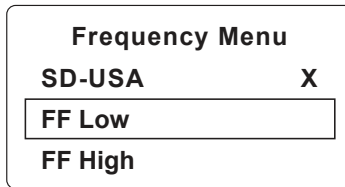

5 and 10-Watt Transmitters

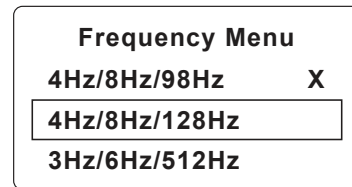

25-Watt Transmitter

- Pressing the “+” or “-” pushbuttons, you can scroll up or down through the available frequencies.

- Once the wanted frequency is inside the box, press the “f” pushbutton to select or deselect the frequency. An “x” will appear in the box for a selected frequency.

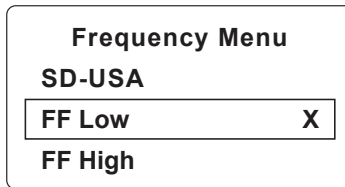

5 and 10-Watt Transmitters

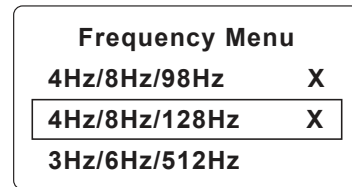

25-Watt Transmitter

- After selecting the frequencies, press the “i” pushbutton again to exit the “Frequency Menu” and return to the main display.
- A particular frequency in the chosen list of frequencies can be selected from the screen by pressing the “f” pushbutton until the wanted frequency is displayed at the top of the main screen.

6.8.3 Multi-Frequency Mode for Direct Connection

This feature can be used to energize two or three frequencies simultaneously on the target line. This is especially helpful when the user is unsure which frequency is best to apply to the target line.



NOTE

- When using the multi-frequency mode, total power will be split between the activated frequencies.
- The multi-frequency mode is not available in Fault Find and SD modes.
- The frequencies have to be available in the main menu.

Enter the Multi-frequency Setup menu:

1. Press the “i” pushbutton seven times to get to the “Multi-Frequency” screen and press the “f” pushbutton to activate the multi-frequency mode. An “x” symbol will appear, indicating that the multi-frequency mode is activated. Press the “f” pushbutton again to go to the “Multi-Frequency. Setup” screen to choose the frequencies.
2. Use the “+” and “-” pushbuttons to scroll through the available frequencies and add the desired frequency in the first box.
3. Press the “f” pushbutton to move the box down and the “+” and “-” pushbuttons to select the second frequency.
4. Repeat step three to select the third frequency if needed.
5. Press the “i” pushbutton to return to the main display. On the main display, “Multi” will appear, indicating the multi-frequency mode is active.
6. The frequencies selected for multi-frequency mode will be saved until changes are made, even when the multi-frequency mode is deactivated.

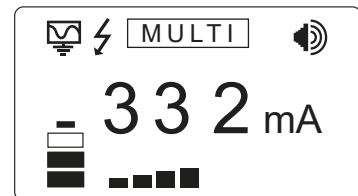
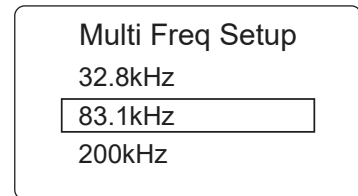
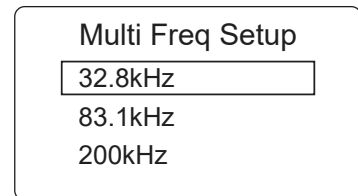
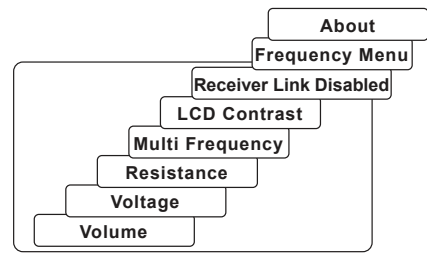

6.9 Transmitter Link (TX-Link) 

Currently the Tx-Link feature is **only available in the 5-watt and 10-watt transmitters.**

The Loc3 series transmitters can be remotely operated from the receiver. This option requires the Transmitter (radio) Link to be installed in both the vLoc3 series receiver and the Loc3 series transmitter.

Tx-Link is a factory fit option that must be purchased at the time of ordering. The radio link range depends on having a clear “line of sight” between Rx and Tx but is typically around 300m (984ft).

The Tx-Link feature is shown as RECEIVER LINK in the menu.

Linking a transmitter to a receiver:

1. Press the “i” button repeatedly to scroll through the options until the “RECEIVER LINK DISABLED” option is displayed.



6 Using the Accessories

2. Press the "+" key to enter the Receiver Link menu.
Press the "+" or "-" key to highlight the "ENABLE" option, then press the "F" key to start the process. The display will show the message "WAIT" until the setup is complete.

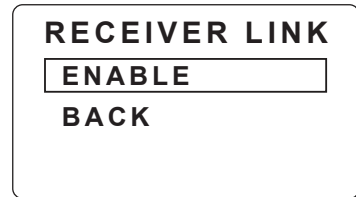

3. An ID number will now be displayed at the bottom of the screen for identification purposes.

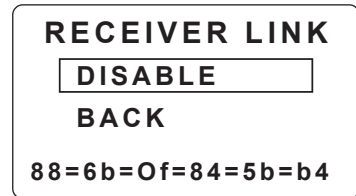

4. The transmitter is now waiting to connect to a receiver.
Either press the "I" button or use the "+" and "-" keys to highlight "BACK" then the "F" key to exit back to the main screen.

When on the main screen, a "beacon" icon will be displayed on the right-hand side. When the icon is flashing, the transmitter is waiting to connect to a receiver. The flashing will stop when successfully connected to the receiver. If no icon is visible, this indicates that the Receiver Radio Link has not been activated.



5. While the icon on the transmitter is flashing, indicating that it is waiting to connect to a receiver, switch on the vLoc3 series receiver and enter the user menu by pressing and holding the information button. Scroll down the menu options until Transmitter Link is highlighted.
Note that the transmitter and receiver sides of the radio links can be switched on in any order.

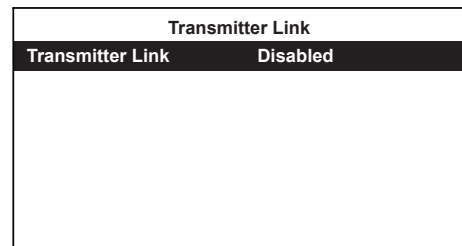
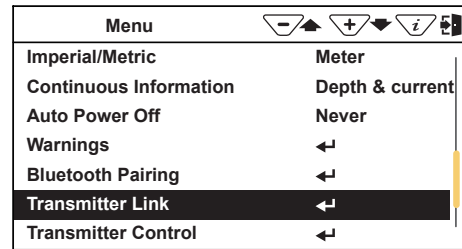

6. Select the "Transmitter Link." Check that the radio module is enabled. If not, press the return button to enable the Transmitter Link.
After a short scan, the available devices will be displayed. Highlight the one to be selected and press the return button. Press the information button to return to the main menu.

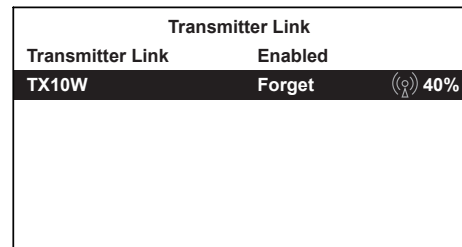

7. The "Beacon" icon on the transmitter should not be flashing anymore at this point. A solid icon indicates that the link has been established.

6 Using the Accessories

8. From the main menu, select the “Transmitter Control” option. (that will become visible when the two devices are linked)
A screen similar to the below should be seen:

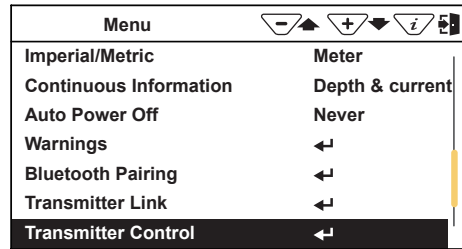

From this screen, if the link status shows “Connected,” it is possible to:

- a. Alter the output level of the transmitter using the “+” and “-” buttons.
- b. Alter the transmit frequency using the “f” button.

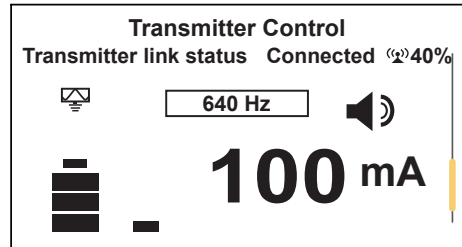

Also shown is the:

- Radio link signal strength, in this case, 40%.
- Output mode, in this case, direct connection.
- Output current, in this case, 100mA.
- Beeper volume setting, in this case, level 2.
- Transmitter battery level.

Use the Information button to navigate/exit back to the locate screen.
When in the Locate screen, the status of the Link is displayed in the Status bar.



The various indications of the status are listed below:

	No radio module or it is disabled (Always disable in the User Menu when not in use)
	No link and no signal
	No link and poor signal
	No link but good signal
	Is linked to the transmitter, but the signal is poor
	Is linked to the transmitter with a good signal

TIP



While the Transmitter and Receiver are linked, changing the Receiver Frequency will automatically result in a similar change to the Transmitter frequency, so there is no need to re-enter the menu screen to change the Transmitter frequency remotely. The Frequency indicator will flash when resetting or if an invalid frequency is requested.

If the Tx/Rx Radio link is not being used, make sure the receiver’s link is set to “Disabled” on both RX and TX. The radio link will continue to search for the transmitter or receiver that may interfere with the Bluetooth operation. Also, disabling when not in use will conserve battery charge.

7. Locator Accessories

7.1 Transmitter Signal Clamps



Clamps are accessories used to apply the transmitter signal to an insulated line, removing the need to connect the transmitter signal directly to a conductor or cable sheath.

Clamps are available in 2-inch (50mm), 4-inch (100mm) and 5-inch sizes. An 18-inch (45cm) flexible version is also available.

7.2 A-Frame Fault Locator



The A-frame accessory is used to detect ground faults on pipes and cables. In the case of pipes, the faults consist of coating defects. In cables, faults are usually caused by insulation damage allowing the metallic sheath (or internal conductor) to contact the earth.

7.3 vLoc3-MLA (Marker Locator Adapter)



The vLoc3-MLA (Marker Locator Adapter) is designed for easy, fast, and accurate location of buried EMS markers. Once located, the MLA will give the depth of cover to the buried marker with the touch of a button.

The MLA attaches to the bottom of vLoc3-Pro, vLoc3-9800, and vLoc3-5000 receivers. When attached and plugged into the receivers, two marker related operating modes are enabled.

Visit us at www.vxmt.com to see the full range of receiver and transmitter accessories and available options.

8. Glossary

Active Locate	A locate where a transmitter is used to apply a signal to a buried pipe or cable, the position of which is then located by a receiver tuned to the same frequency.
Active Signal	A signal is applied by the locator transmitter to a buried line. Typical, this is a very precise frequency.
Attenuation	The reduction of an electromagnetic signal from a pipe or cable.
Clamp (or Coupler)	An accessory used to apply the transmitter signal to an insulated line, removing the need to connect the transmitter signal directly to a conductor or cable sheath.
Compass	Line direction indicator (although visually like a compass, this is the only relation to a compass.)
Coupling	The act of signals transferring to lines to which they were not originally applied. The coupling can be "direct" where the target line has an electrical connection to another line, or "induced" where the signal radiates from the target line to another line or lines.
Display	The information visually available on the dot matrix display.
Line	A generic term for any buried pipe or cable.
Null	A minimum response to a buried line. 
Passive Locate	A locate where the receiver searches for a wide range of signals that radiate from buried pipes or cables. These signals come from various sources in the environment and couple to the buried (& overhead) lines. Typical examples 50 / 60Hz and LF/VLF radio.
Passive signals	A wide range of signals that radiate from buried pipes or cables. These signals come from various sources in the environment and couple to the buried (& overhead) lines. Typical examples 50/60Hz and LF/VLF radio.
Peak	A maximum response to a buried line. 
Pinpoint	Using a receiver to identify the exact position of a buried line.
Response	The indication that the receiver gives, which is caused by the signals it is receiving. This can be visual, audio, or both. Typically, it is displayed on the locator's dot matrix display and audibly from a loudspeaker in the receiver housing.
Search (sweep)	This describes the act of looking for a buried line within a given area.
Sonde	A small transmitting coil may be built into a product such as a sewer camera or packaged as a small self-contained battery-powered transmitter. A receiver tuned to the same frequency can locate the Sonde's position and hence whatever it is attached to or in. Frequently used for locating sewer cameras and the nonmetallic pipes.
Target Line	The buried pipe or cable to be located.
Trace	Using a locator to following the path of a buried line.

.....
 Illustrations used in this manual's preparation will inevitably show some resemblance to similar illustrations from other manufacturers. These manufacturers have permitted the use of their graphics. This statement is intended to attribute such credit.

The Bluetooth® word mark and logos are registered trademarks owned by the Bluetooth SIG, Inc.
 iOS is a trademark of Cisco Systems, Inc., registered in the U.S.
 Android, Google and Google Maps are registered trademarks of Google LLC.

Disclaimer: Product and accessory specification and availability information are subject to change without prior notice.



